

## PHG T10-1250-10 SKF

Metric timing belt, T section

TYPE: Classical timing belts, Oneway, Metric, Section T10 (SKF)

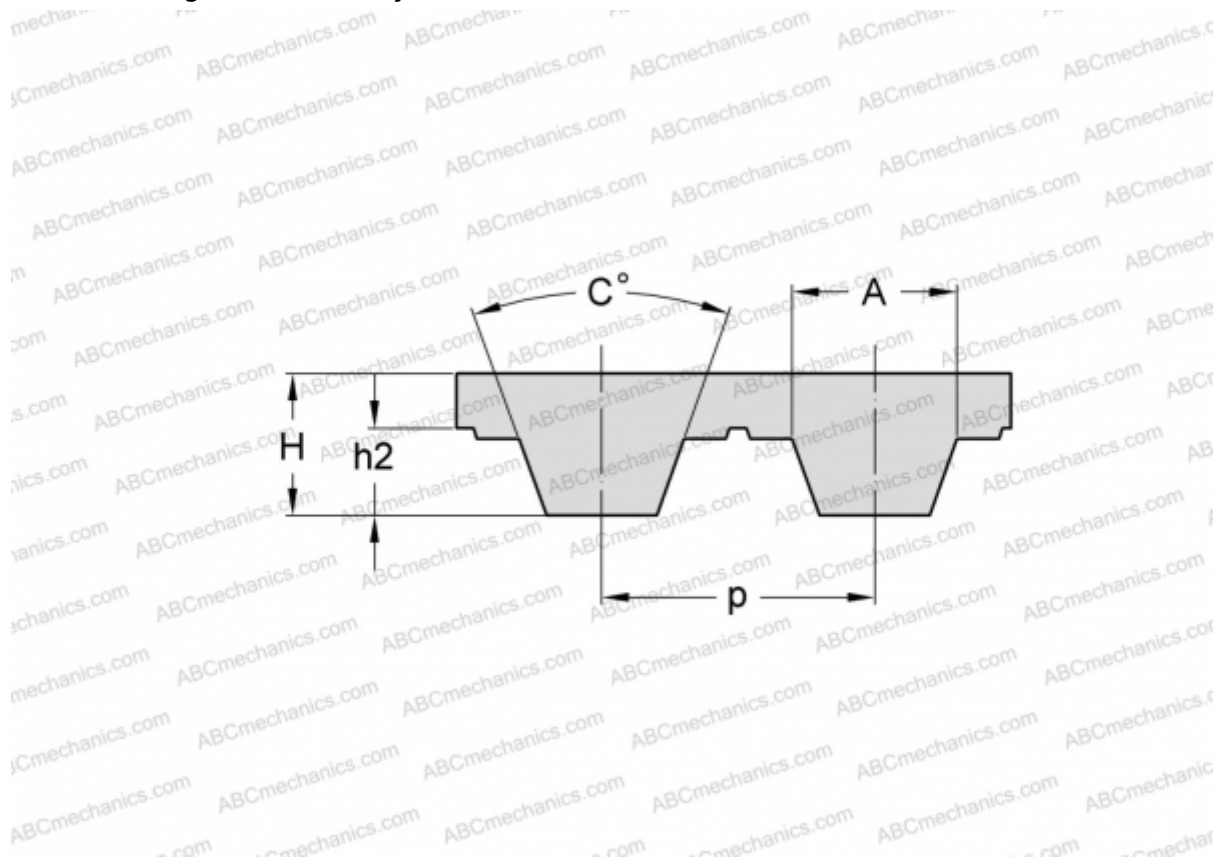

### Technical specification

#### DIMENSIONS, MM

Pitch teeth, $p$	10,000
Estimated length	1250,000
Height, $H$	4,500
$C$	40,000
$h_2$	2,500
$A$	5,300
Number of teeth	125

#### MANUFACTURER

[SKF](#)