

PHG T10-1400-32 SKF

Metric timing belt, T section

TYPE: Classical timing belts, Oneway, Metric, Section T10 (SKF)

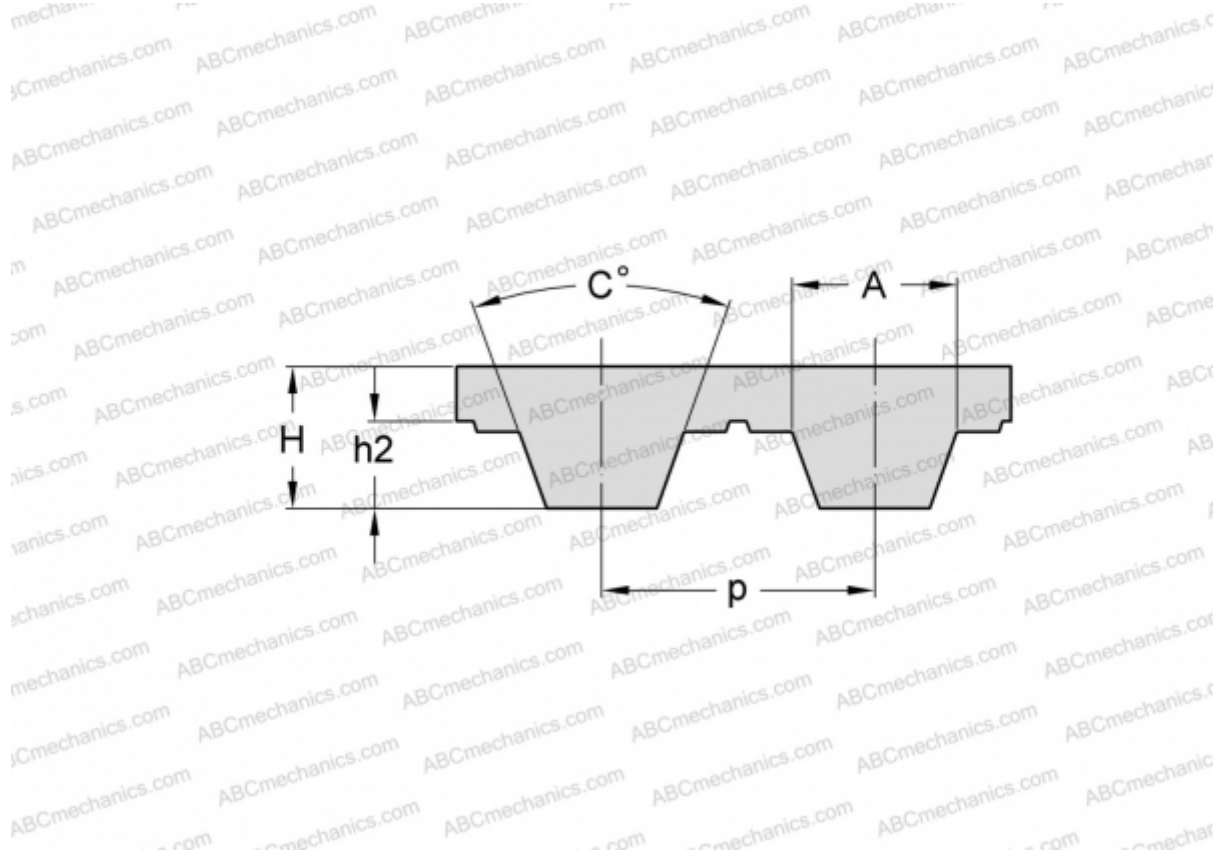

Technical specification

DIMENSIONS, MM

Pitch teeth, p	10,000
Estimated length	1400,000
Height, H	4,500
C	40,000
h_2	2,500
A	5,300
Number of teeth	140

MANUFACTURER [SKF](#)