

PHG T20-2600-170 SKF

Metric timing belt, T section

TYPE: Classical timing belts, Oneway, Metric, Section T20 (SKF)

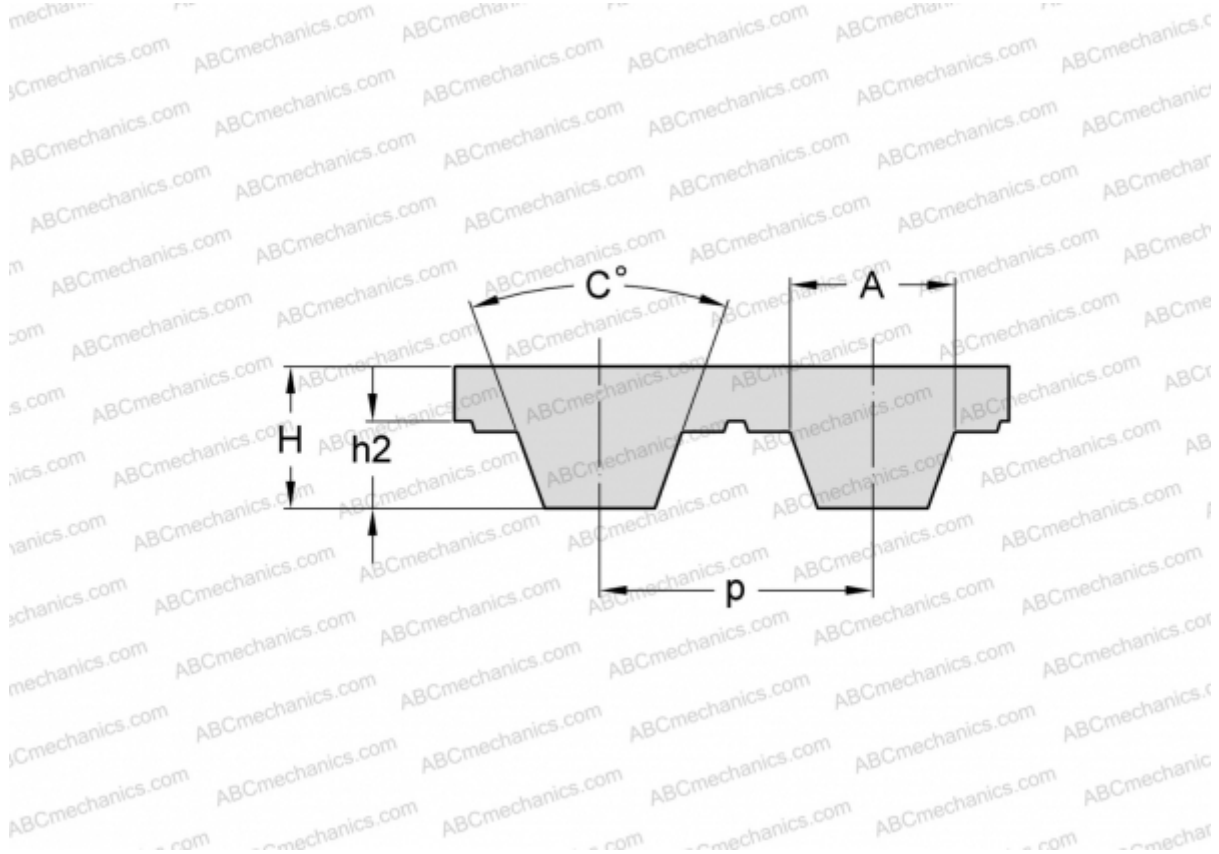

Technical specification

DIMENSIONS, MM

Pitch teeth, p	20,000
Estimated length	2600,000
Width, W	170,000
Height, H	8,000
C	40,000
h_2	5,000
A	10,150
Number of teeth	130

MANUFACTURER [SKF](#)