

PHG T20-3620-115 SKF

Metric timing belt, T section

TYPE: Classical timing belts, Oneway, Metric, Section T20 (SKF)

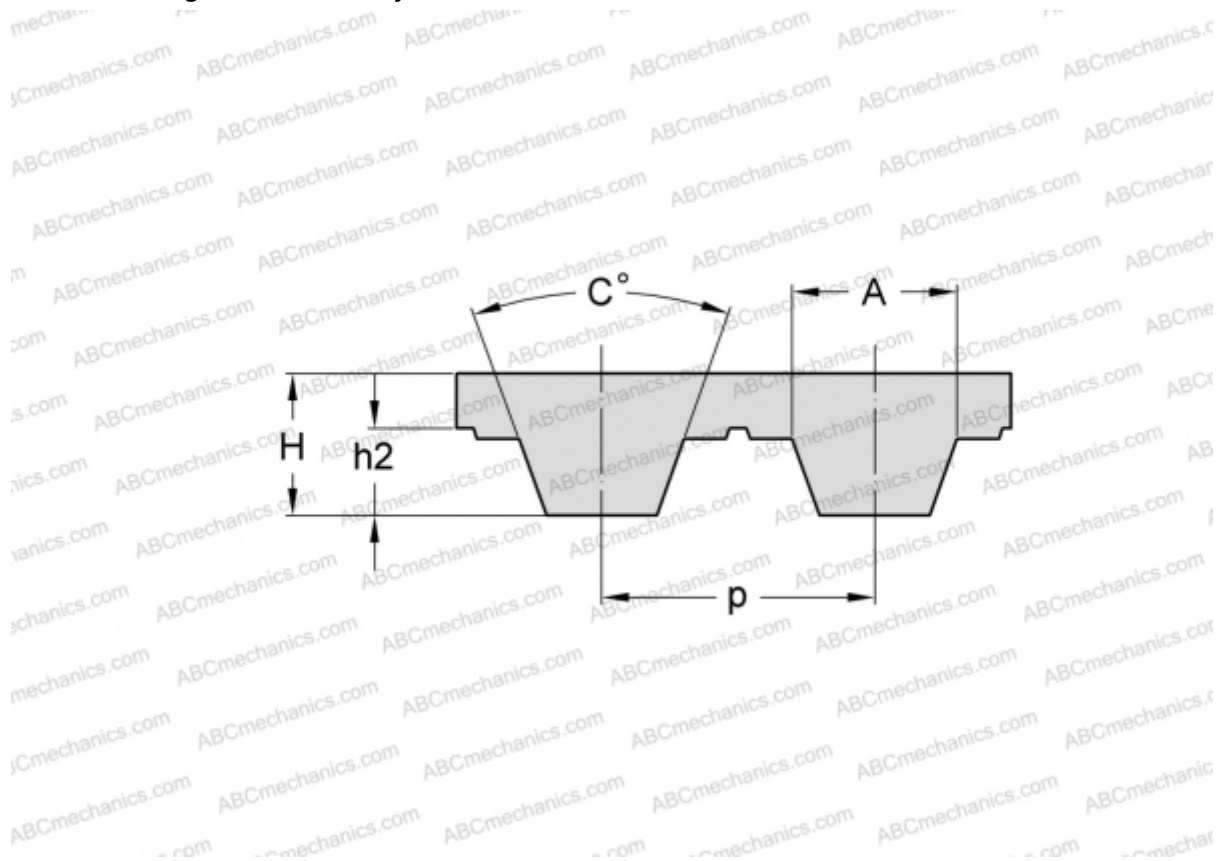

Technical specification

DIMENSIONS, MM

Pitch teeth, p	20,000
Estimated length	3620,000
Width, W	115,000
Height, H	8,000
C	40,000
h_2	5,000
A	10,150
Number of teeth	181

MANUFACTURER [SKF](#)