

PHG AT5-455-12 SKF

Metric timing belt, T section

TYPE: Classical timing belts, Oneway, Metric, Section AT5 (SKF)

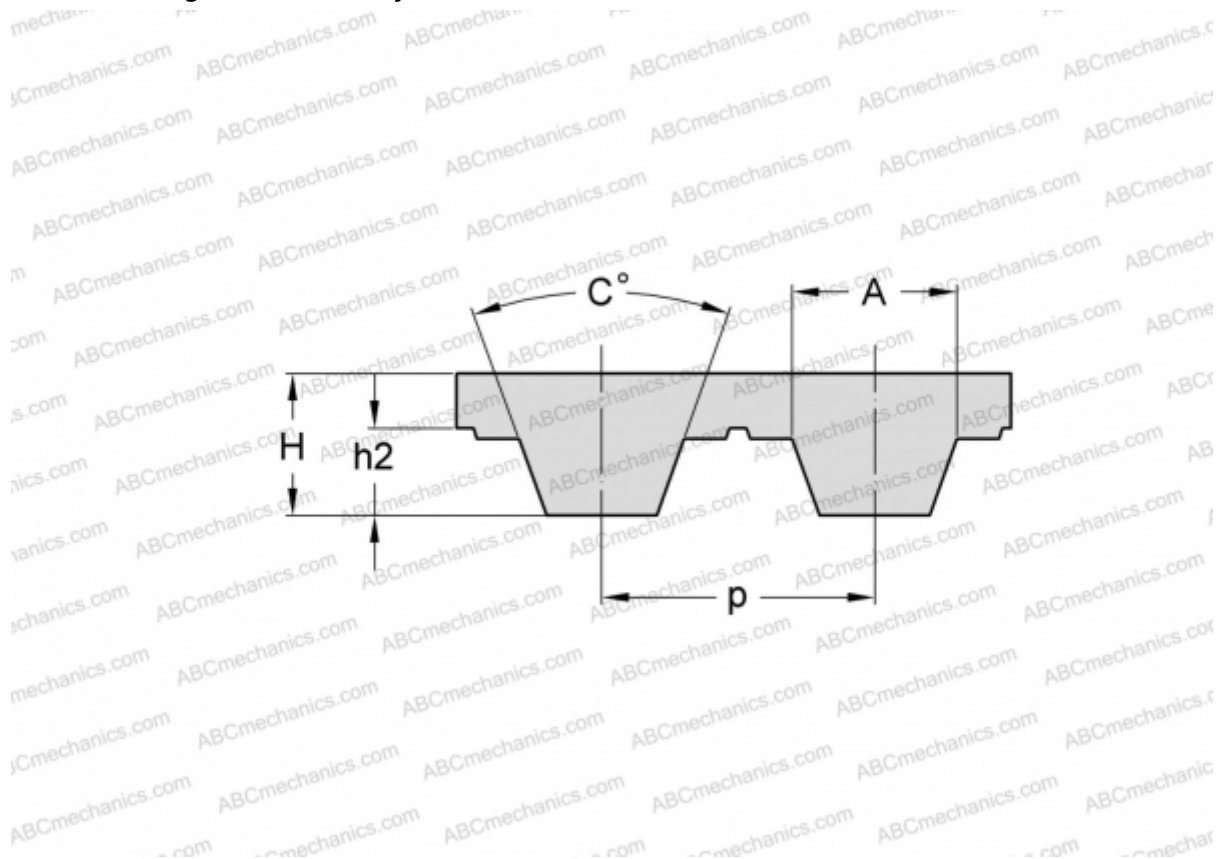

Technical specification

DIMENSIONS, MM

Pitch teeth, p	5,000
Estimated length	455,000
Width, W	12,000
Height, H	2,700
C	50,000
h2	1,200
A	3,620
Number of teeth	91

MANUFACTURER

[SKF](#)