

PHG AT5-600-10 SKF

Metric timing belt, T section

TYPE: Classical timing belts, Oneway, Metric, Section AT5 (SKF)

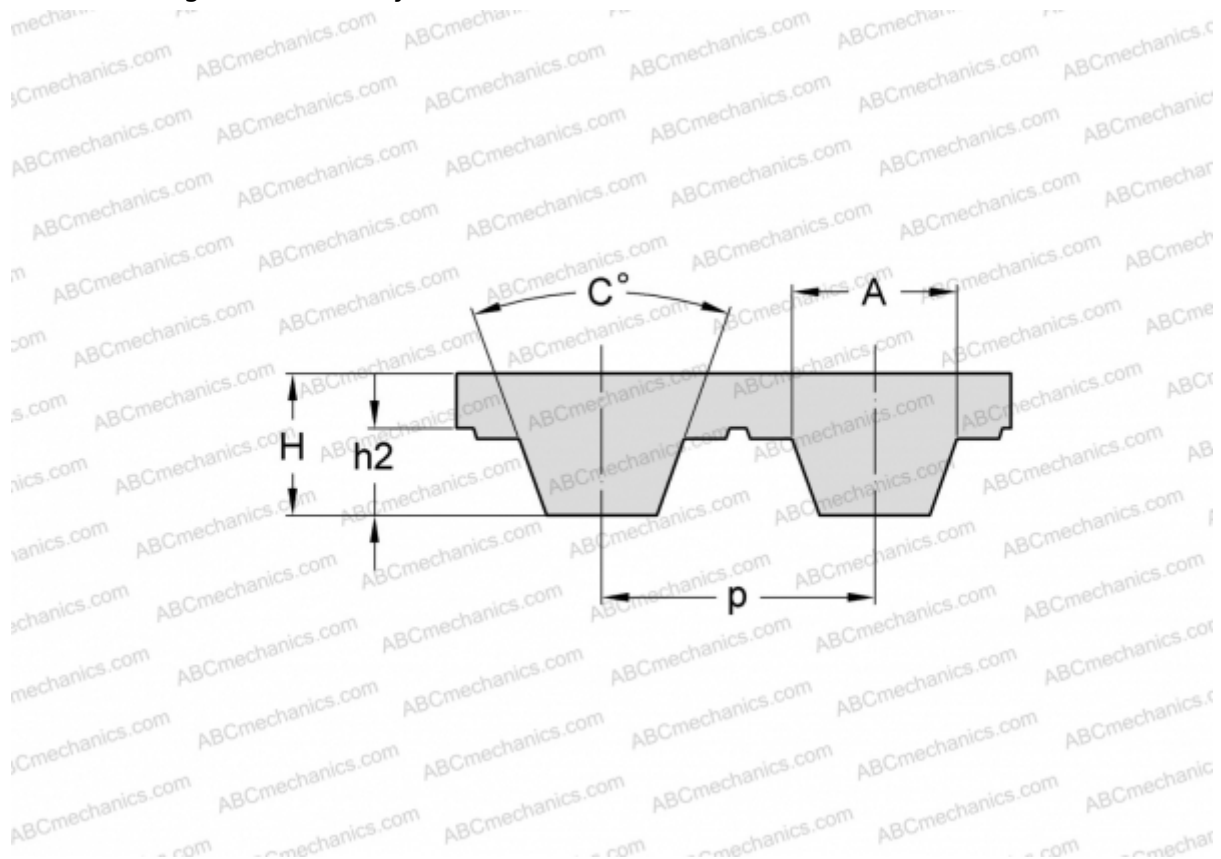

Technical specification

DIMENSIONS, MM

Pitch teeth, p	5,000
Estimated length	600,000
Width, W	10,000
Height, H	2,700
C	50,000
h2	1,200
A	3,620
Number of teeth	120

MANUFACTURER [SKF](#)