

PHG AT5-630-8 SKF

Metric timing belt, T section

TYPE: Classical timing belts, Oneway, Metric, Section AT5 (SKF)

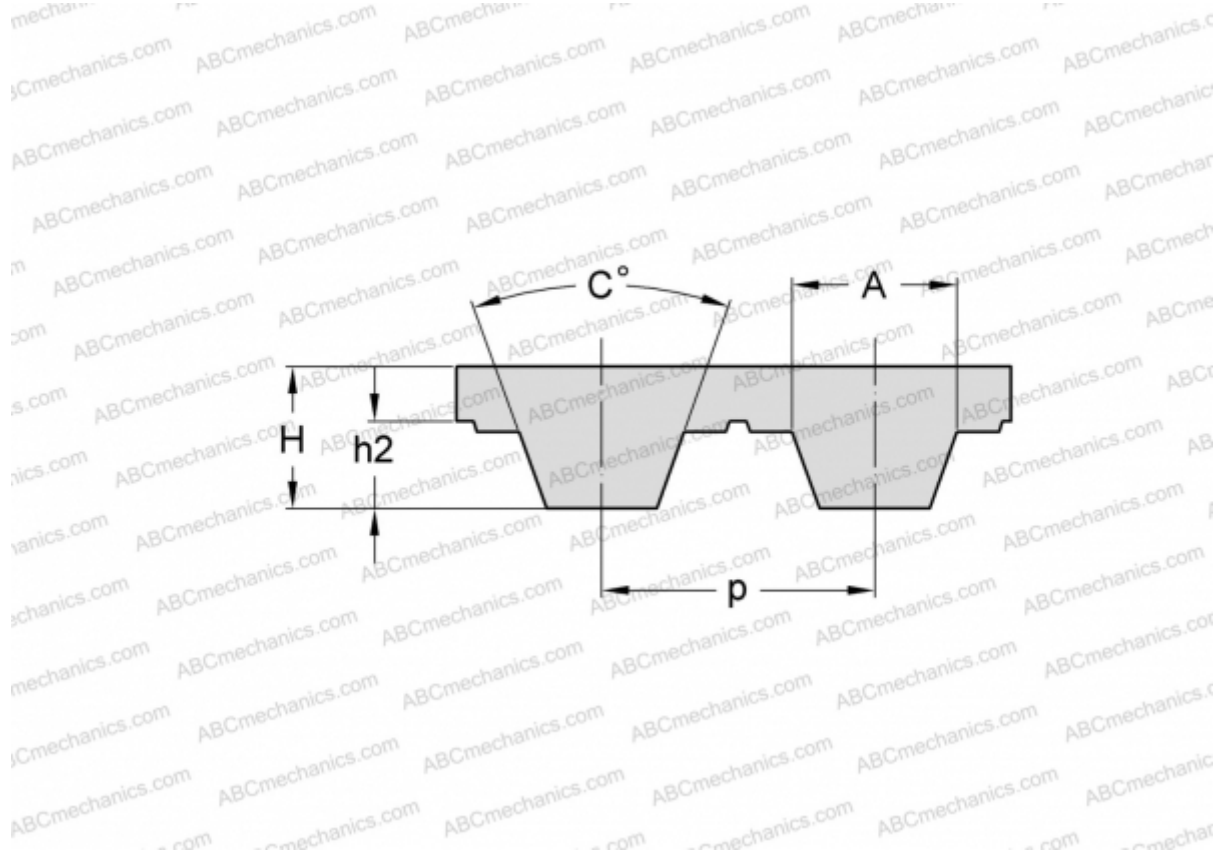

Technical specification

DIMENSIONS, MM

Pitch teeth, p	5,000
Estimated length	630,000
Width, W	8,000
Height, H	2,700
C	50,000
h2	1,200
A	3,620
Number of teeth	126

MANUFACTURER [SKF](#)