

## PHG AT5-690-12 SKF

Metric timing belt, T section

TYPE: Classical timing belts, Oneway, Metric, Section AT5 (SKF)

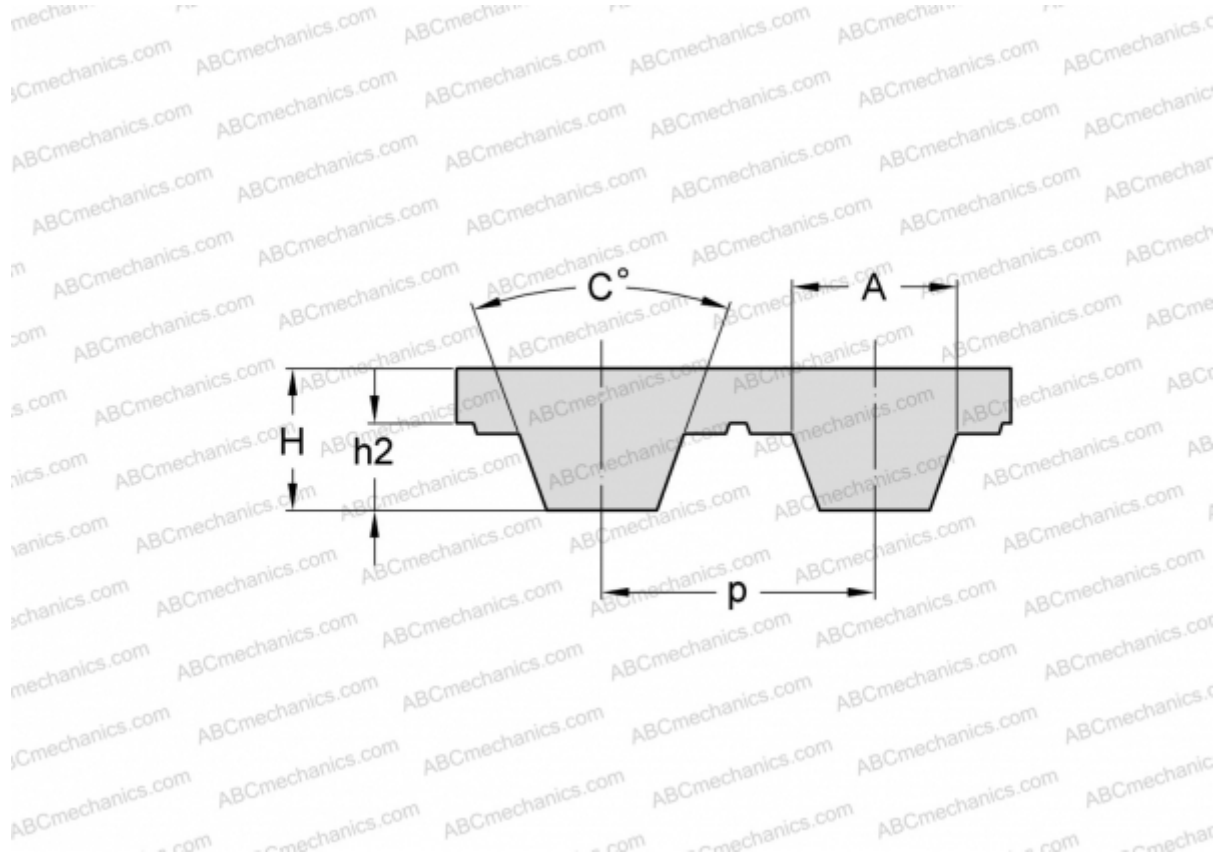

### Technical specification

#### DIMENSIONS, MM

Pitch teeth, $p$	5,000
Estimated length	690,000
Width, $W$	12,000
Height, $H$	2,700
$C$	50,000
$h_2$	1,200
$A$	3,620
Number of teeth	138

#### MANUFACTURER

[SKF](#)