

## PHG AT10-580-10 SKF

Metric timing belt, T section

TYPE: Classical timing belts, Oneway, Metric, Section AT10 (SKF)

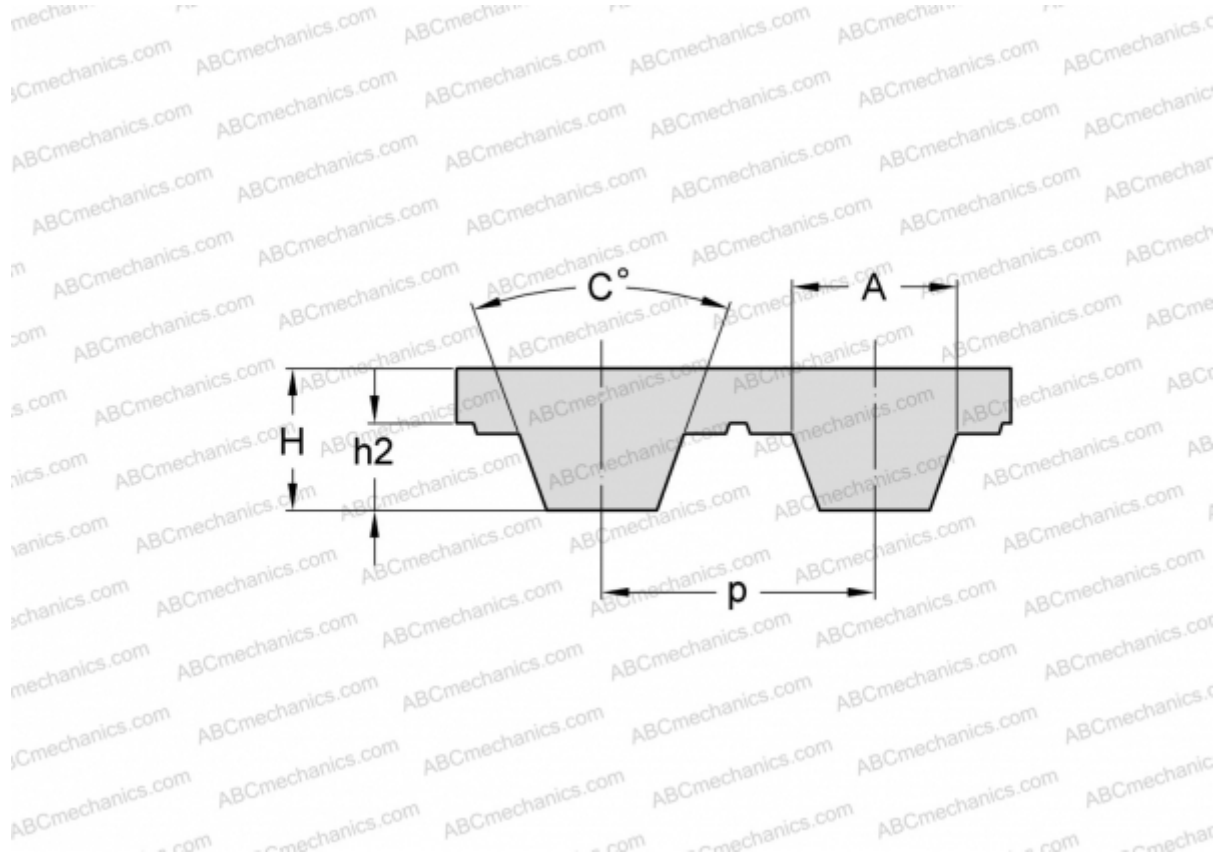

### Technical specification

#### DIMENSIONS, MM

Pitch teeth, p	10,000
Estimated length	580,000
Width, W	10,000
Height, H	5,000
C	50,000
h2	2,500
A	7,300
Number of teeth	58

#### MANUFACTURER

[SKF](#)