

PHG AT10-840-20 SKF

Metric timing belt, T section

TYPE: Classical timing belts, Oneway, Metric, Section AT10 (SKF)

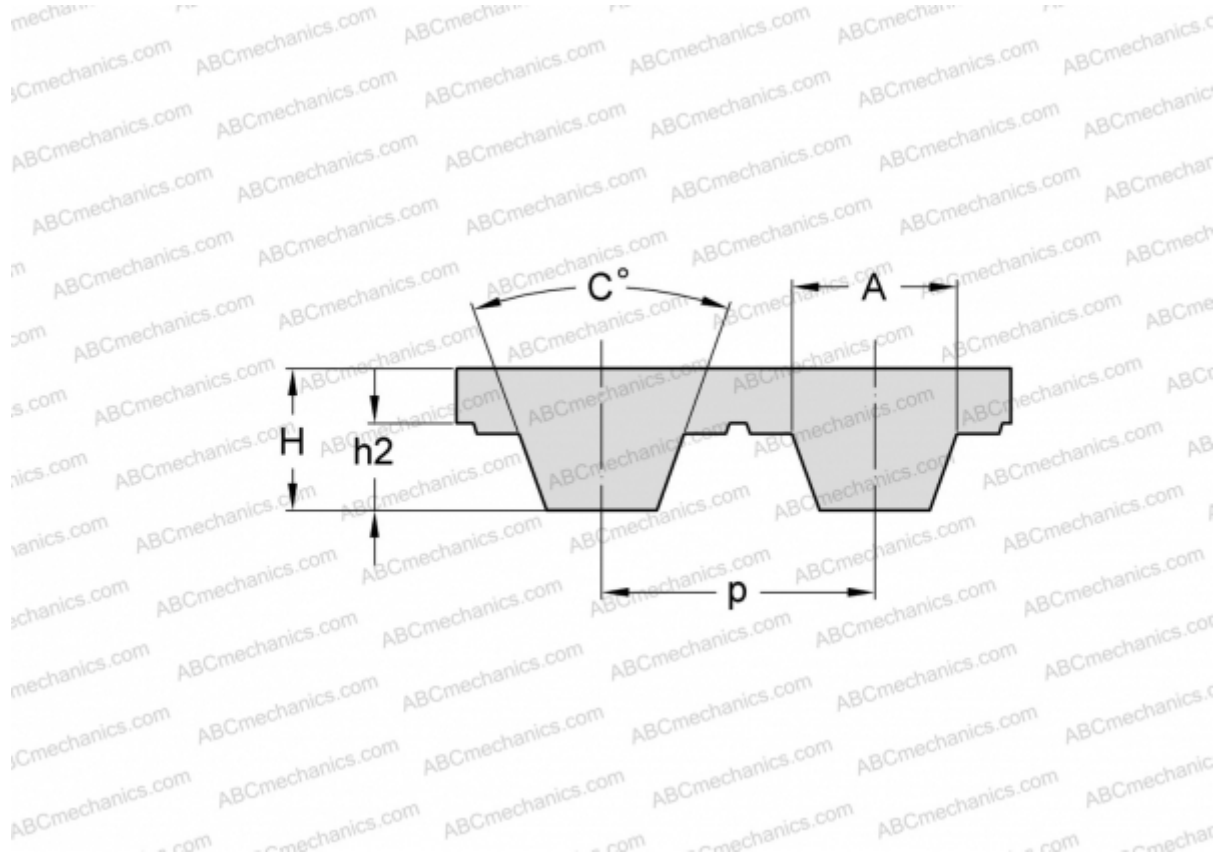

Technical specification

DIMENSIONS, MM

Pitch teeth, p	10,000
Estimated length	840,000
Width, W	20,000
Height, H	5,000
C	50,000
h_2	2,500
A	7,300
Number of teeth	84

MANUFACTURER

[SKF](#)