

## PHG AT10-960-50 SKF

Metric timing belt, T section

TYPE: Classical timing belts, Oneway, Metric, Section AT10 (SKF)

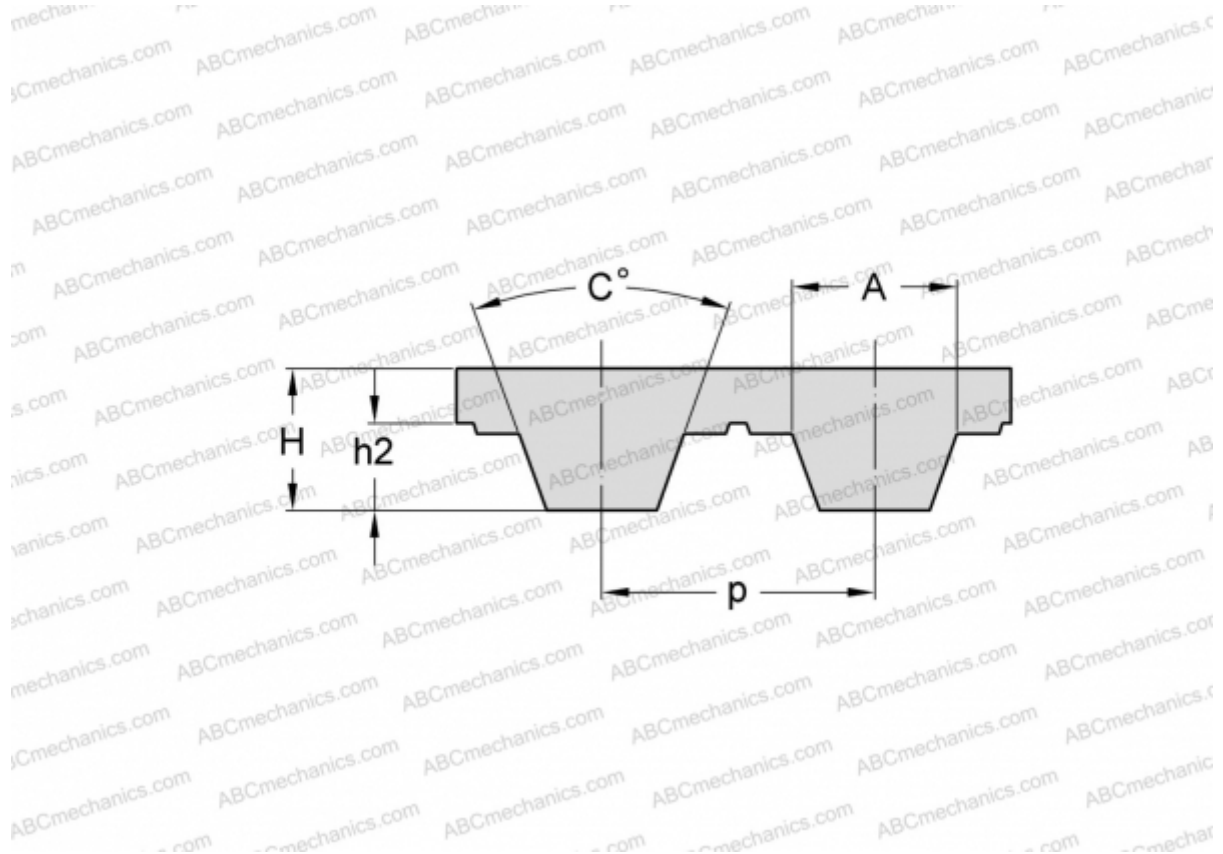

### Technical specification

#### DIMENSIONS, MM

Pitch teeth, $p$	10,000
Estimated length	960,000
Width, $W$	50,000
Height, $H$	5,000
$C$	50,000
$h_2$	2,500
$A$	7,300
Number of teeth	96

#### MANUFACTURER

[SKF](#)