

PHG AT10-1610-50 SKF

Metric timing belt, T section

TYPE: Classical timing belts, Oneway, Metric, Section AT10 (SKF)

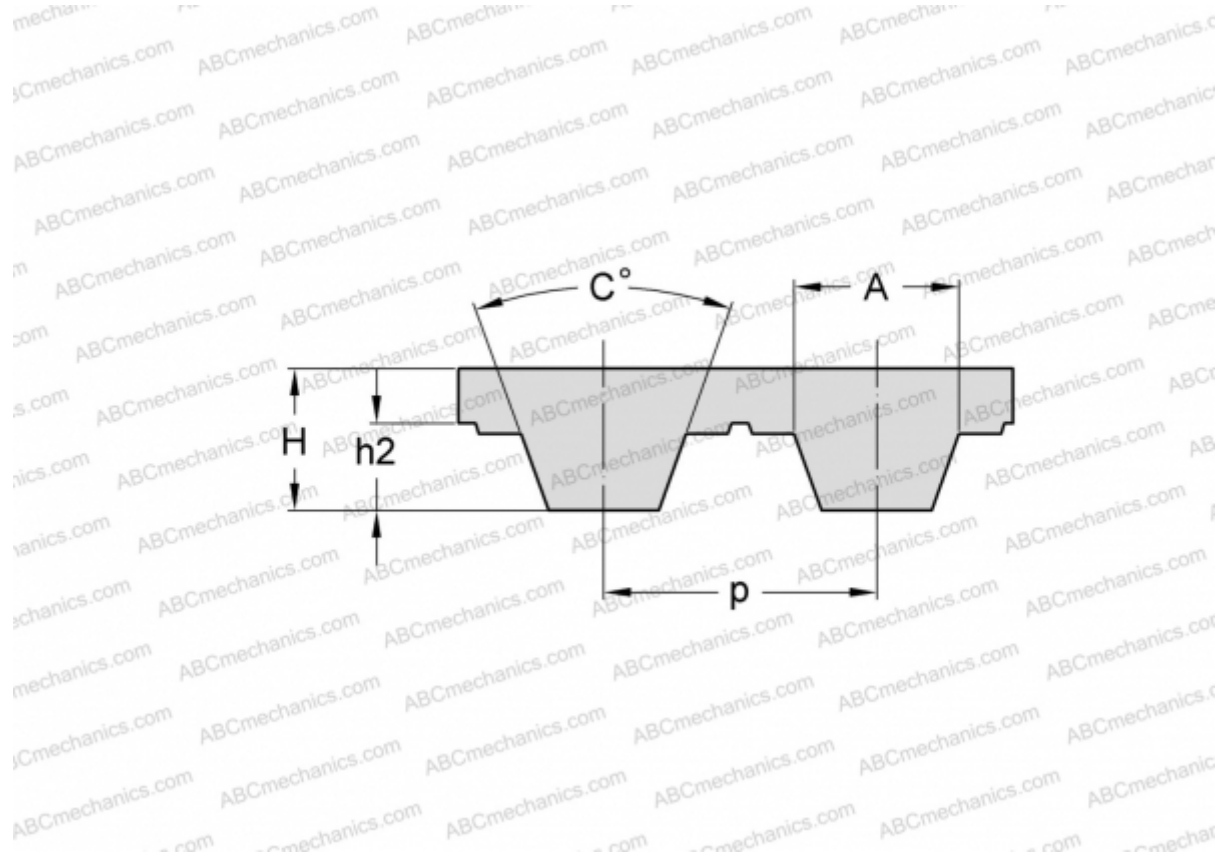

Technical specification

DIMENSIONS, MM

Pitch teeth, p	10,000
Estimated length	1610,000
Width, W	50,000
Height, H	5,000
C	50,000
h2	2,500
A	7,300
Number of teeth	161

MANUFACTURER [SKF](#)