

## PHG AT20-1700-170 SKF

Metric timing belt, T section

TYPE: Classical timing belts, Oneway, Metric, Section AT20 (SKF)

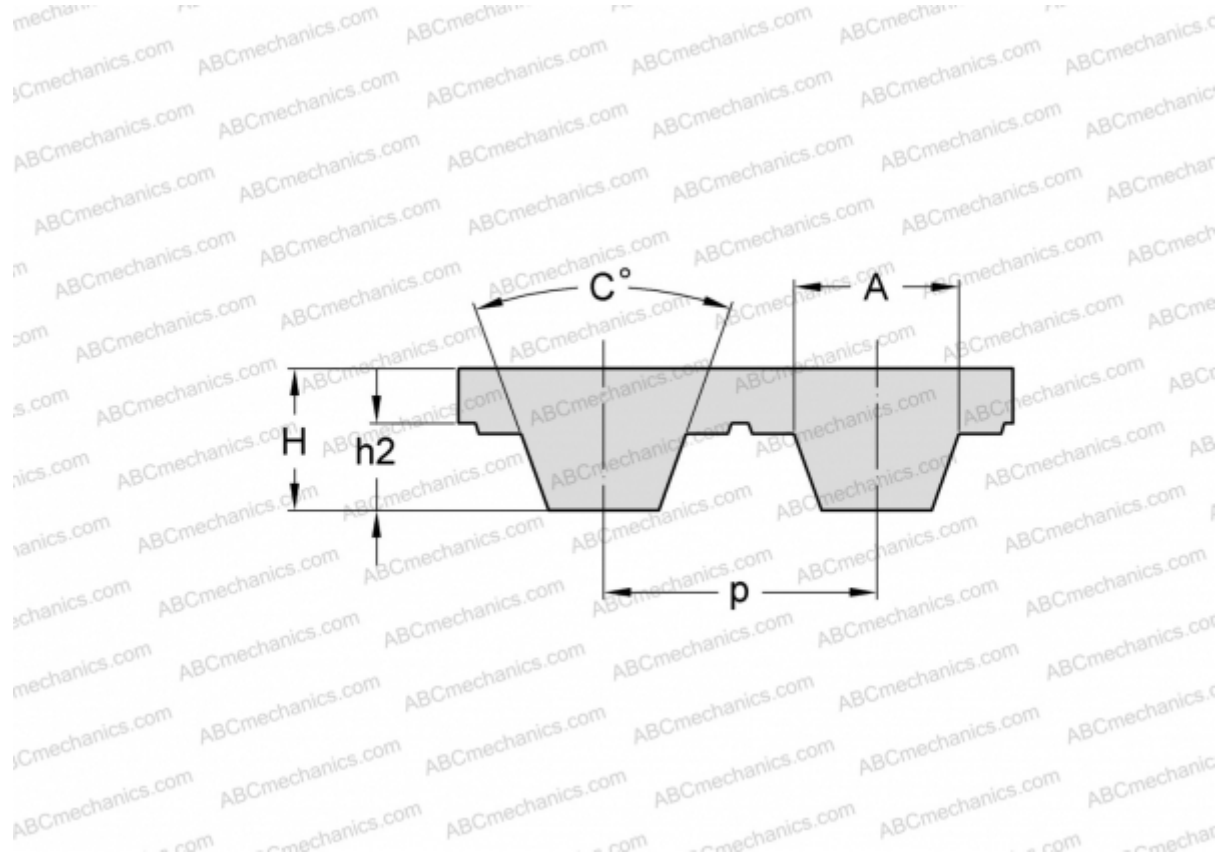

### Technical specification

#### DIMENSIONS, MM

Pitch teeth, $p$	20,000
Estimated length	1700,000
Width, $W$	170,000
Height, $H$	8,000
$C$	50,000
$h_2$	5,000
$A$	12,700
Number of teeth	85

#### MANUFACTURER

[SKF](#)