

PHG AT20-1900-230 SKF

Metric timing belt, T section

TYPE: Classical timing belts, Oneway, Metric, Section AT20 (SKF)

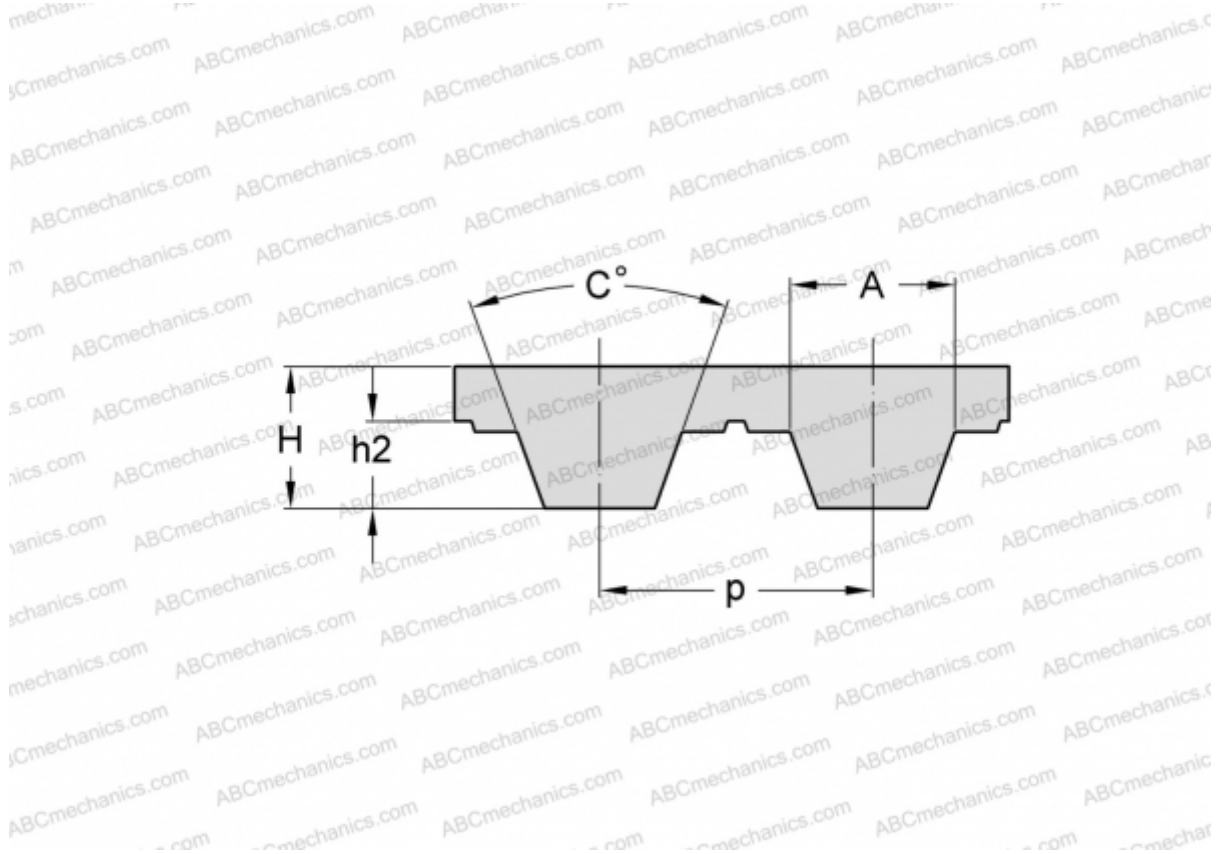

Technical specification

DIMENSIONS, MM

Pitch teeth, p	20,000
Estimated length	1900,000
Width, W	230,000
Height, H	8,000
C	50,000
h_2	5,000
A	12,700
Number of teeth	95

MANUFACTURER

[SKF](#)