

PHG D-202-XL-031 SKF

Double-sided classical timing belt

TYPE: Classical timing belts, Twoway, Classical, Section D-XL (SKF)

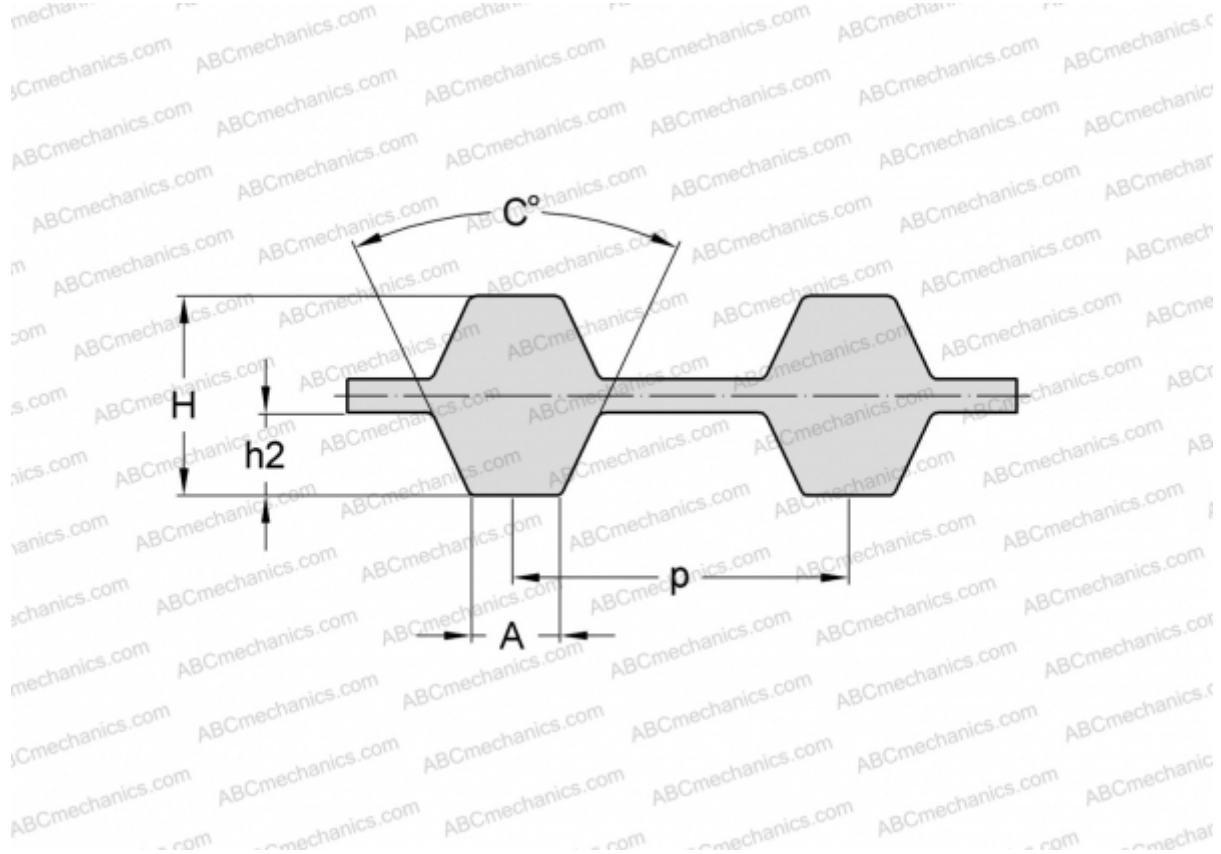

Technical specification

DIMENSIONS, MM

Pitch teeth, p	5,080
Estimated length	513,080
Width, W	7,874
Height, H	3,050
C	50,000
h2	1,270
A	2,570
Number of teeth	101

MANUFACTURER [SKF](#)