

## PHG D-220-XL-037 SKF

Double-sided classical timing belt

TYPE: Classical timing belts, Twoway, Classical, Section D-XL (SKF)

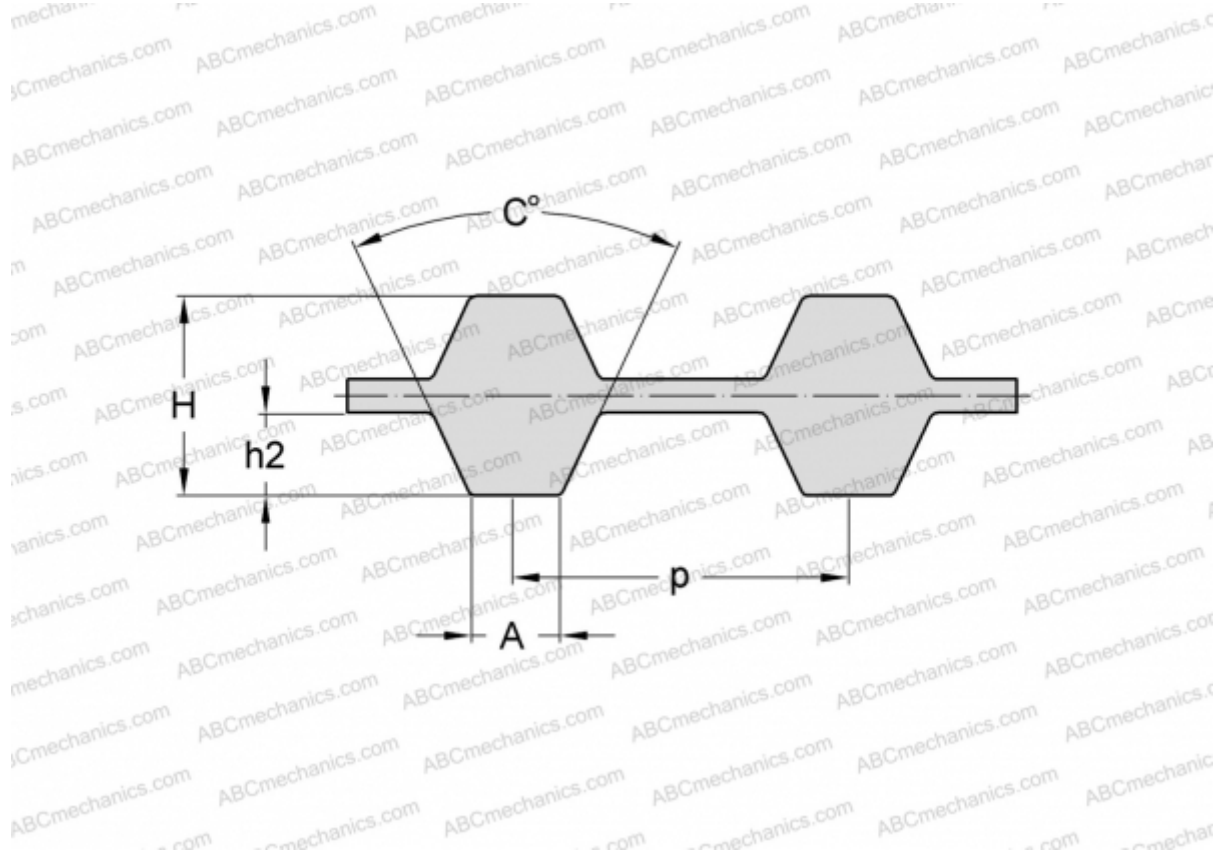

### Technical specification

#### DIMENSIONS, MM

Pitch teeth, p	5,080
Estimated length	558,800
Width, W	9,398
Height, H	3,050
C	50,000
h2	1,270
A	2,570
Number of teeth	110

**MANUFACTURER** [SKF](#)