

PHG D-258-L-100 SKF

Double-sided classical timing belt

TYPE: Classical timing belts, Twoway, Classical, Section D-L (SKF)

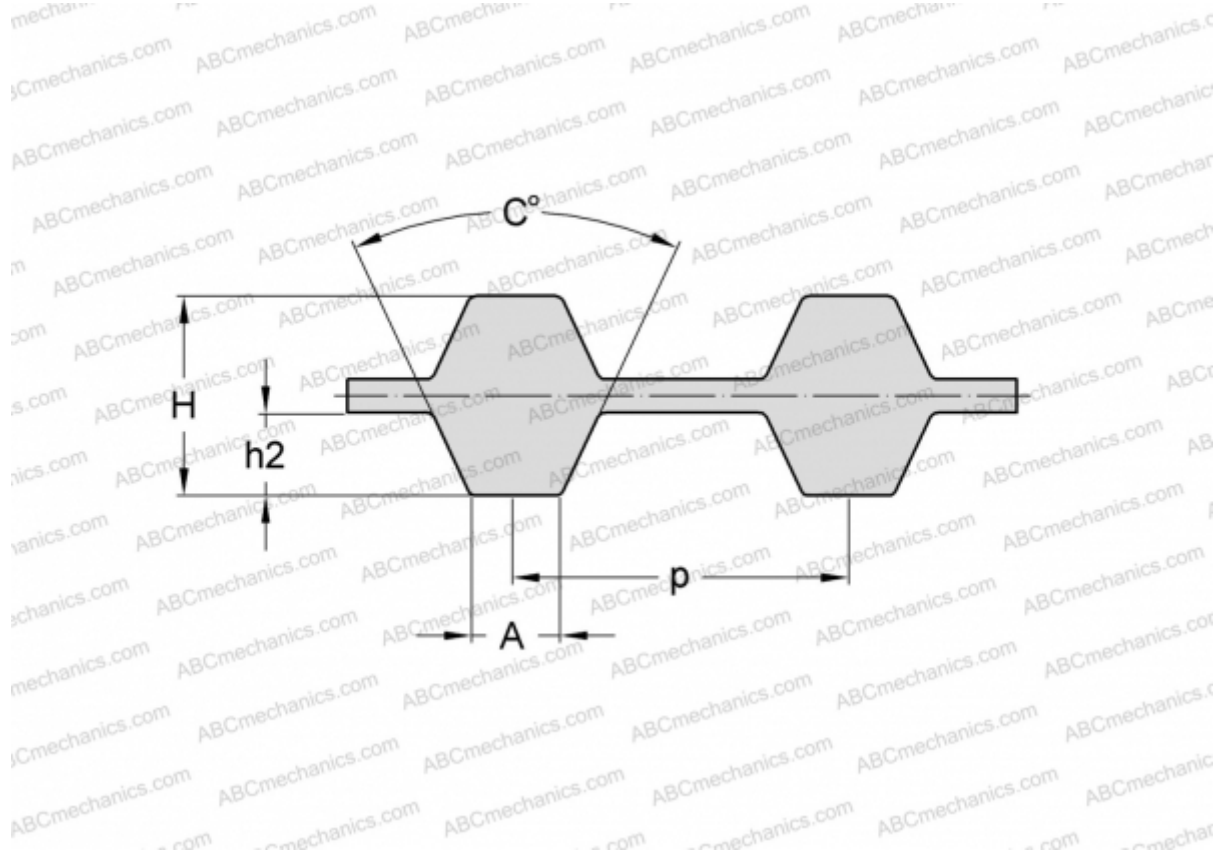

Technical specification

DIMENSIONS, MM

Pitch teeth, p	9,525
Estimated length	654,050
Width, W	25,400
Height, H	4,570
C	40,000
h2	1,910
A	4,650
Number of teeth	69

MANUFACTURER

[SKF](#)