

PHG D-285-L-100 SKF

Double-sided classical timing belt

TYPE: Classical timing belts, Twoway, Classical, Section D-L (SKF)

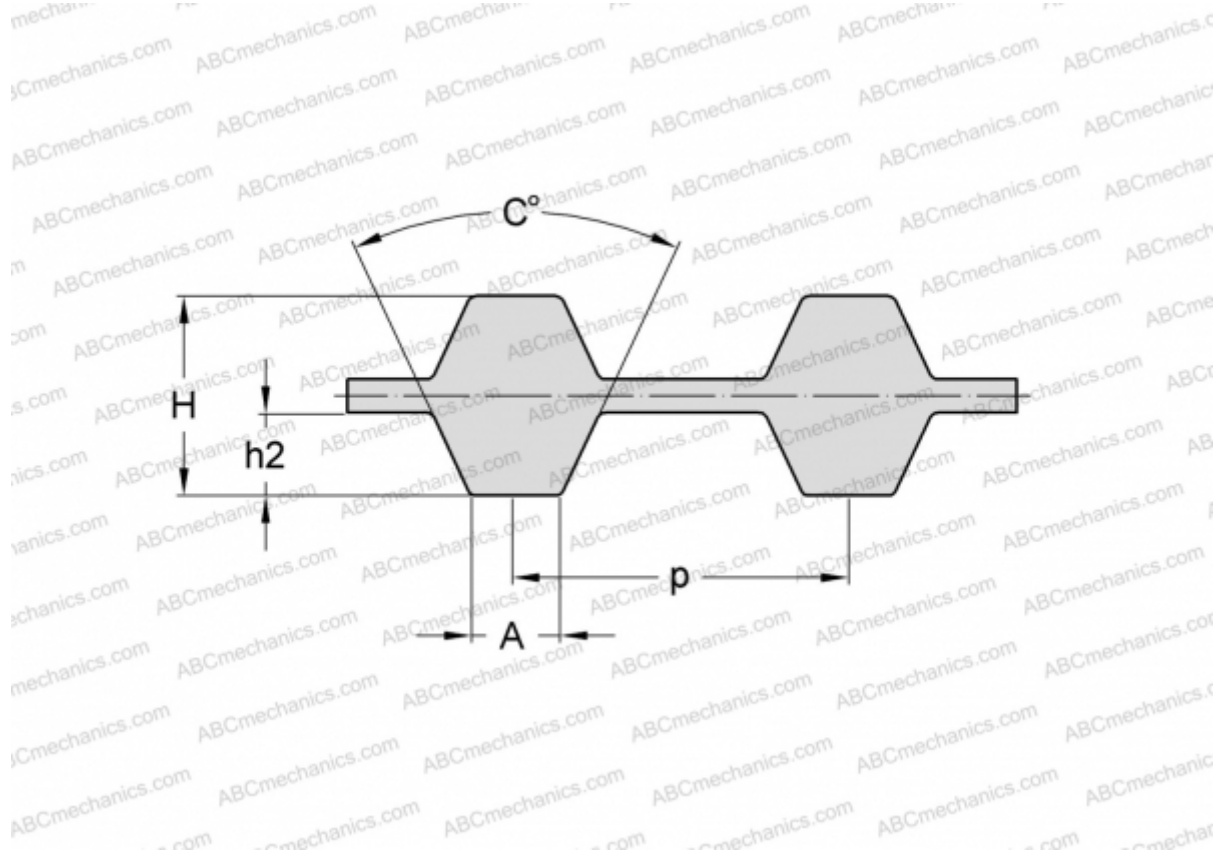

Technical specification

DIMENSIONS, MM

| | |
|------------------|---------|
| Pitch teeth, p | 9,525 |
| Estimated length | 723,900 |
| Width, W | 25,400 |
| Height, H | 4,570 |
| C | 40,000 |
| h2 | 1,910 |
| A | 4,650 |
| Number of teeth | 76 |

MANUFACTURER

[SKF](#)