

PHG D-290-H-075 SKF

Double-sided classical timing belt

TYPE: Classical timing belts, Twoway, Classical, Section D-H (SKF)

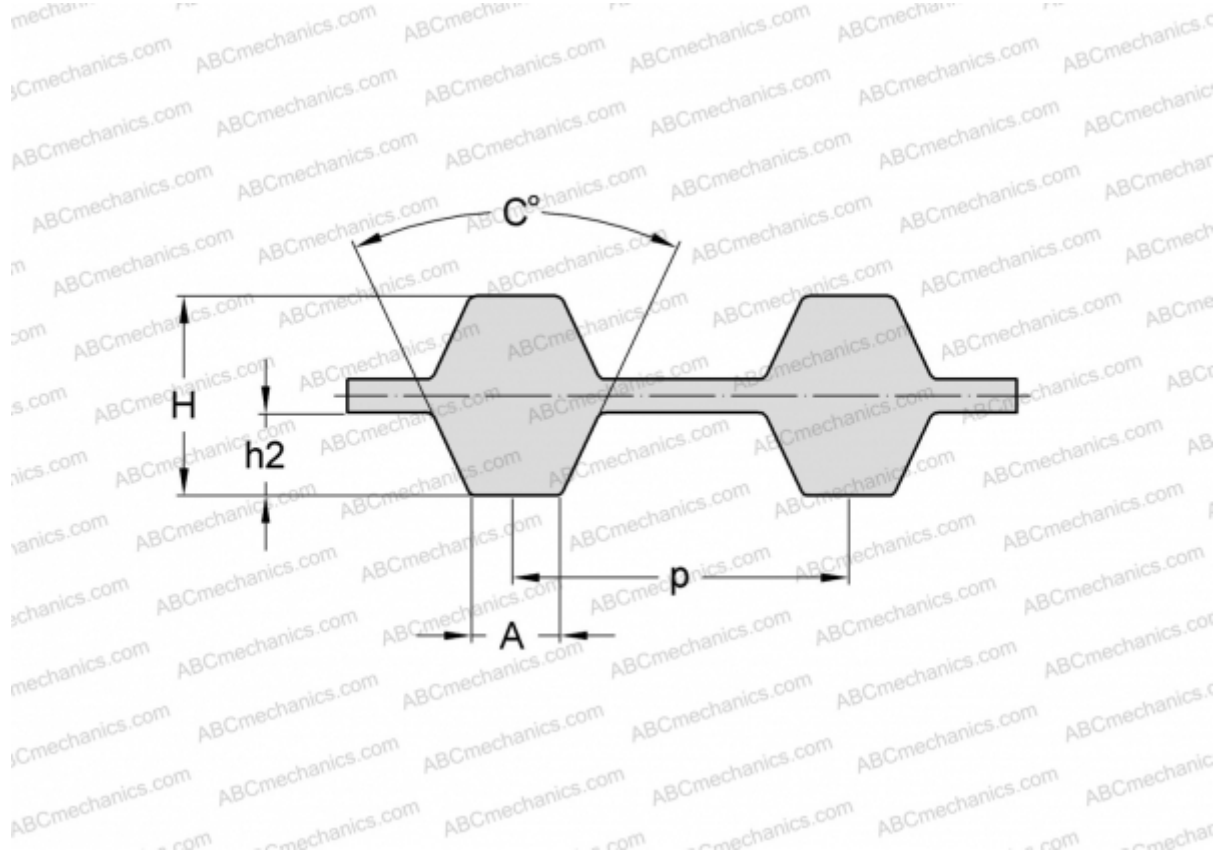

Technical specification

DIMENSIONS, MM

Pitch teeth, p	12,700
Estimated length	736,600
Width, W	19,050
Height, H	5,950
C	40,000
h2	2,290
A	6,120
Number of teeth	58

MANUFACTURER

[SKF](#)