

## PHG D-800-H-300 SKF

Double-sided classical timing belt

TYPE: Classical timing belts, Twoway, Classical, Section D-H (SKF)

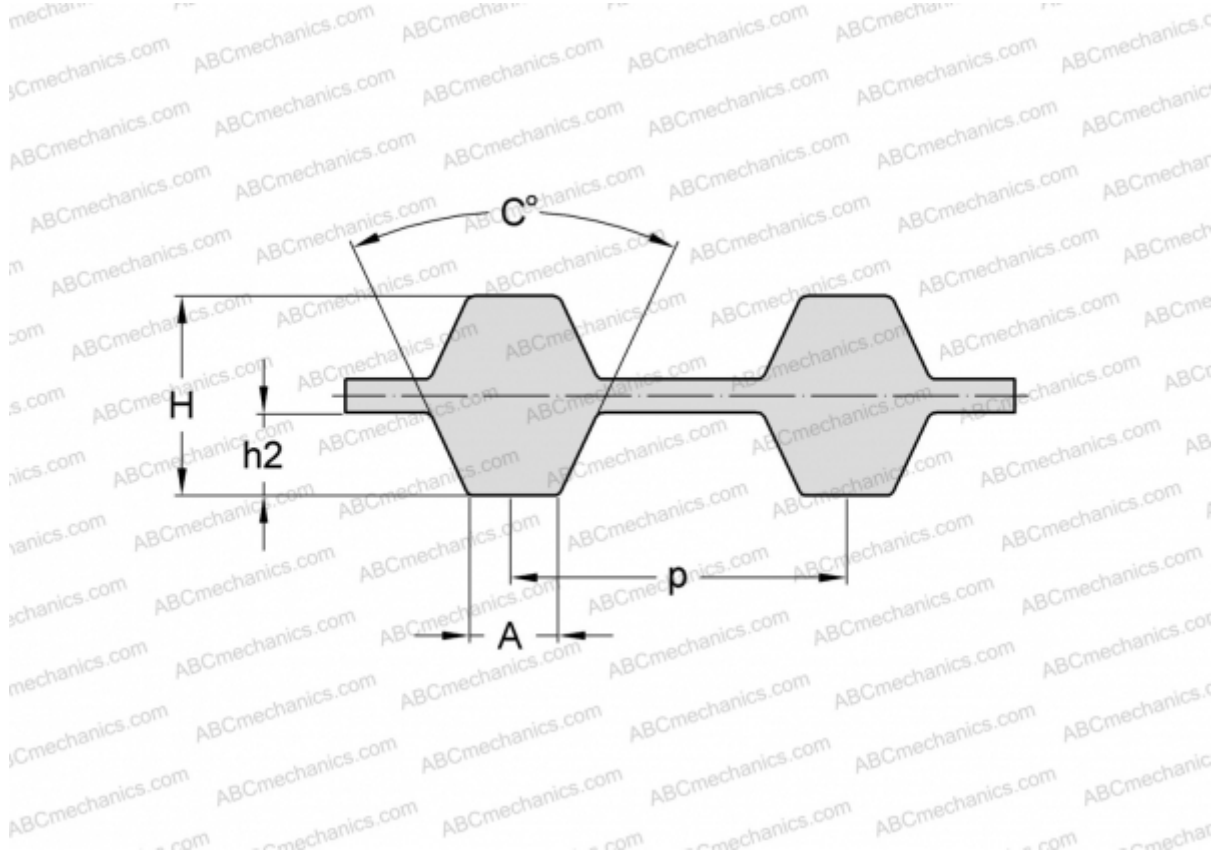

### Technical specification

#### DIMENSIONS, MM

Pitch teeth, p	12,700
Estimated length	2032,000
Width, W	76,200
Height, H	5,950
C	40,000
h2	2,290
A	6,120
Number of teeth	160

**MANUFACTURER** [SKF](#)