

PHG D-1120-H-100 SKF

Double-sided classical timing belt

TYPE: Classical timing belts, Twoway, Classical, Section D-H (SKF)

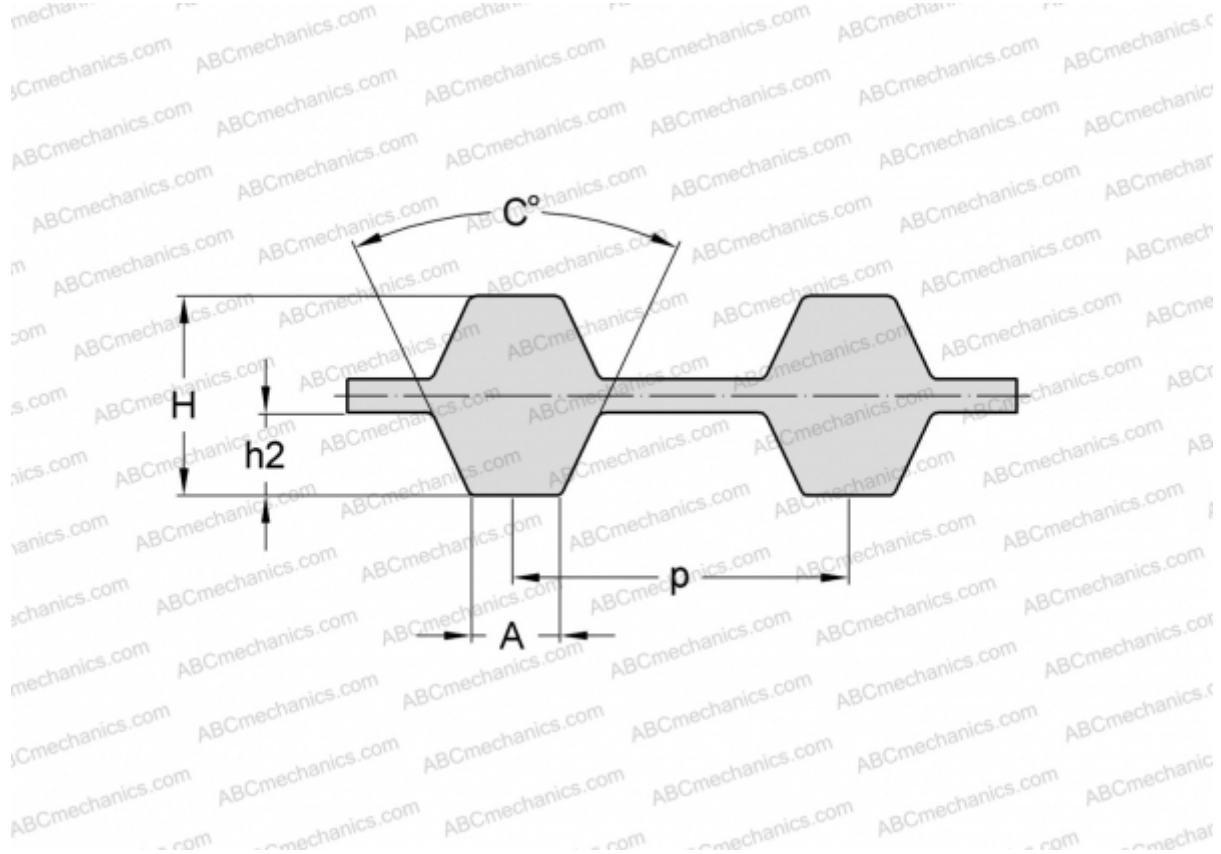

Technical specification

DIMENSIONS, MM

Pitch teeth, p	12,700
Estimated length	2844,800
Width, W	25,400
Height, H	5,950
C	40,000
h2	2,290
A	6,120
Number of teeth	224

MANUFACTURER [SKF](#)