

PHG DA-685-5M-9 SKF

Double-sided HiTD belt

TYPE: Classical timing belts, Twoway, HiTD, Section D-5M (SKF)

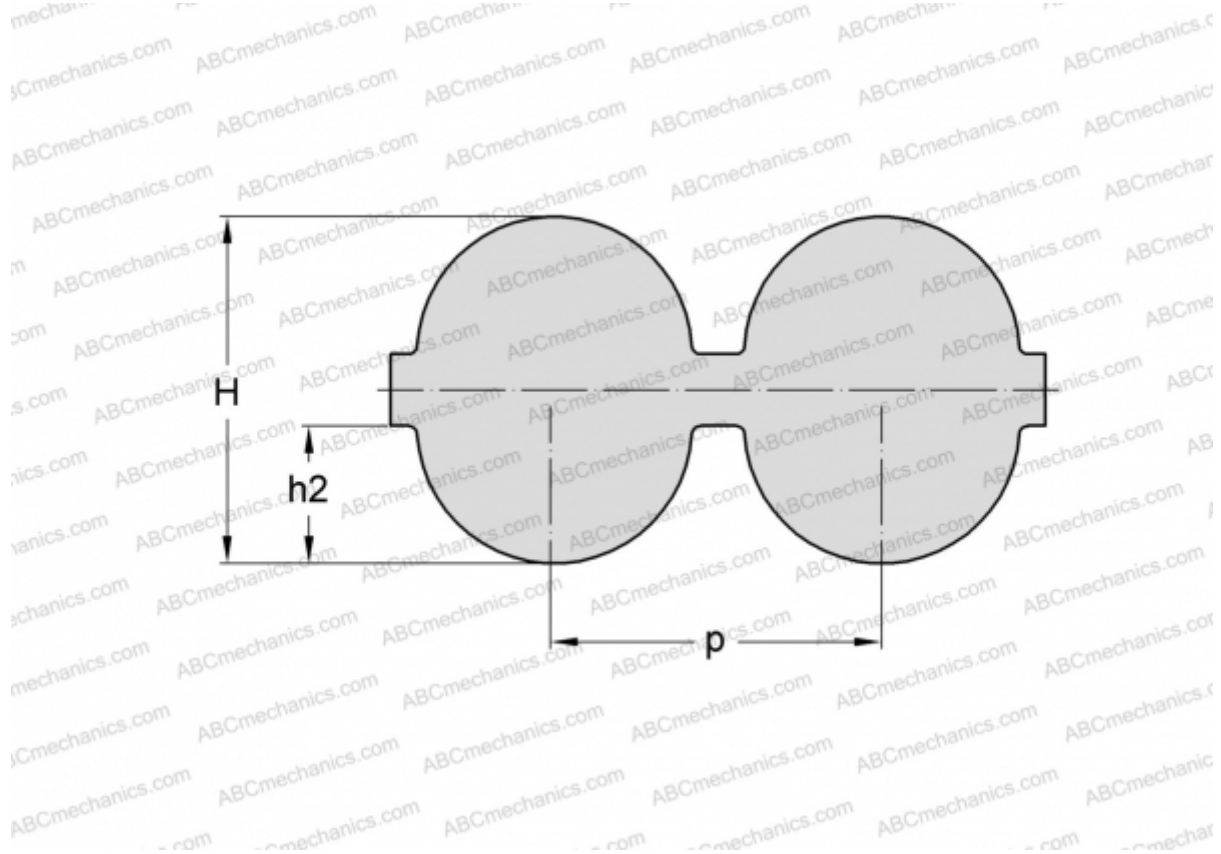

Technical specification

DIMENSIONS, MM

Pitch teeth, p	5,000
Estimated length	685,000
Width, W	9,000
Height, H	5,300
h2	2,100
Number of teeth	137

MANUFACTURER [SKF](#)