

PHG DA-745-5M-9 SKF

Double-sided HiTD belt

TYPE: Classical timing belts, Twoway, HiTD, Section D-5M (SKF)

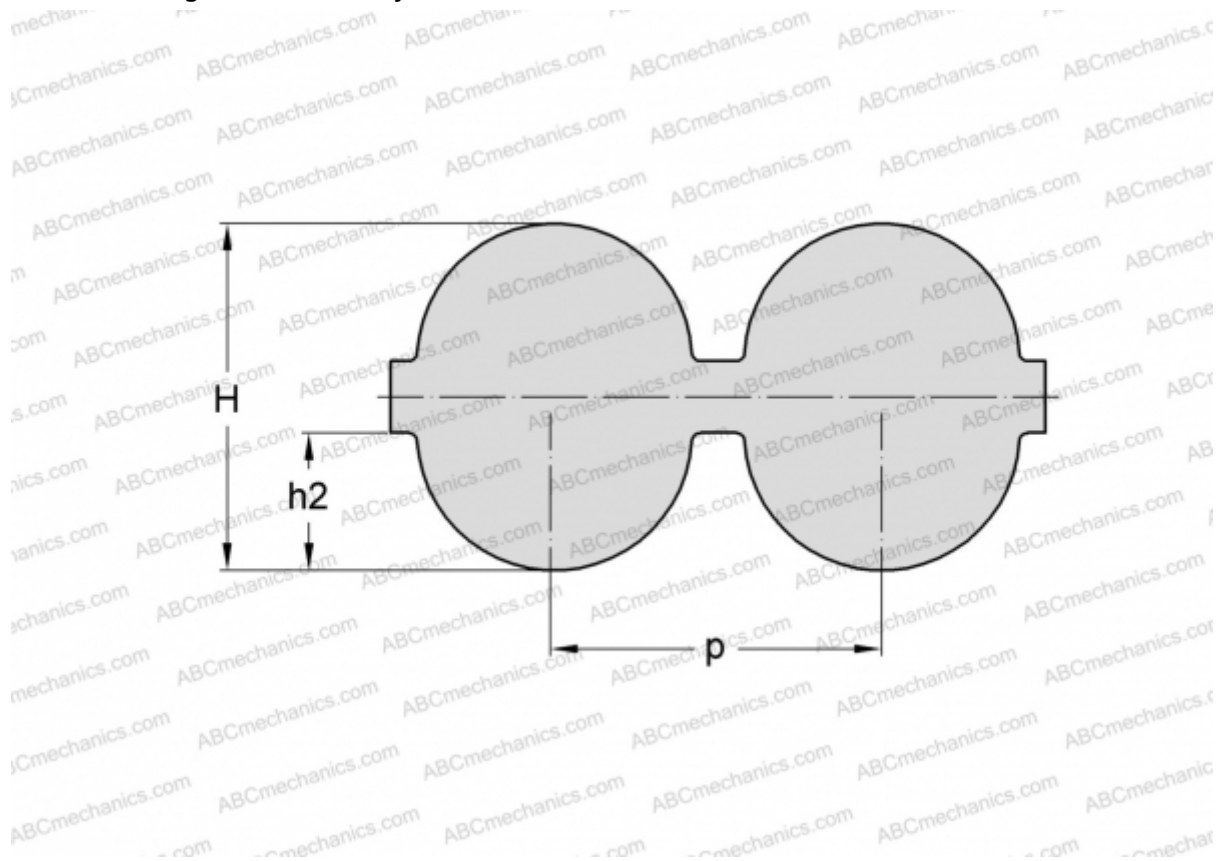

Technical specification

DIMENSIONS, MM

| | |
|------------------|---------|
| Pitch teeth, p | 5,000 |
| Estimated length | 745,000 |
| Width, W | 9,000 |
| Height, H | 5,300 |
| h2 | 2,100 |
| Number of teeth | 149 |

MANUFACTURER

[SKF](#)