

## PHG DA-830-5M-15 SKF

Double-sided HiTD belt

TYPE: Classical timing belts, Twoway, HiTD, Section D-5M (SKF)

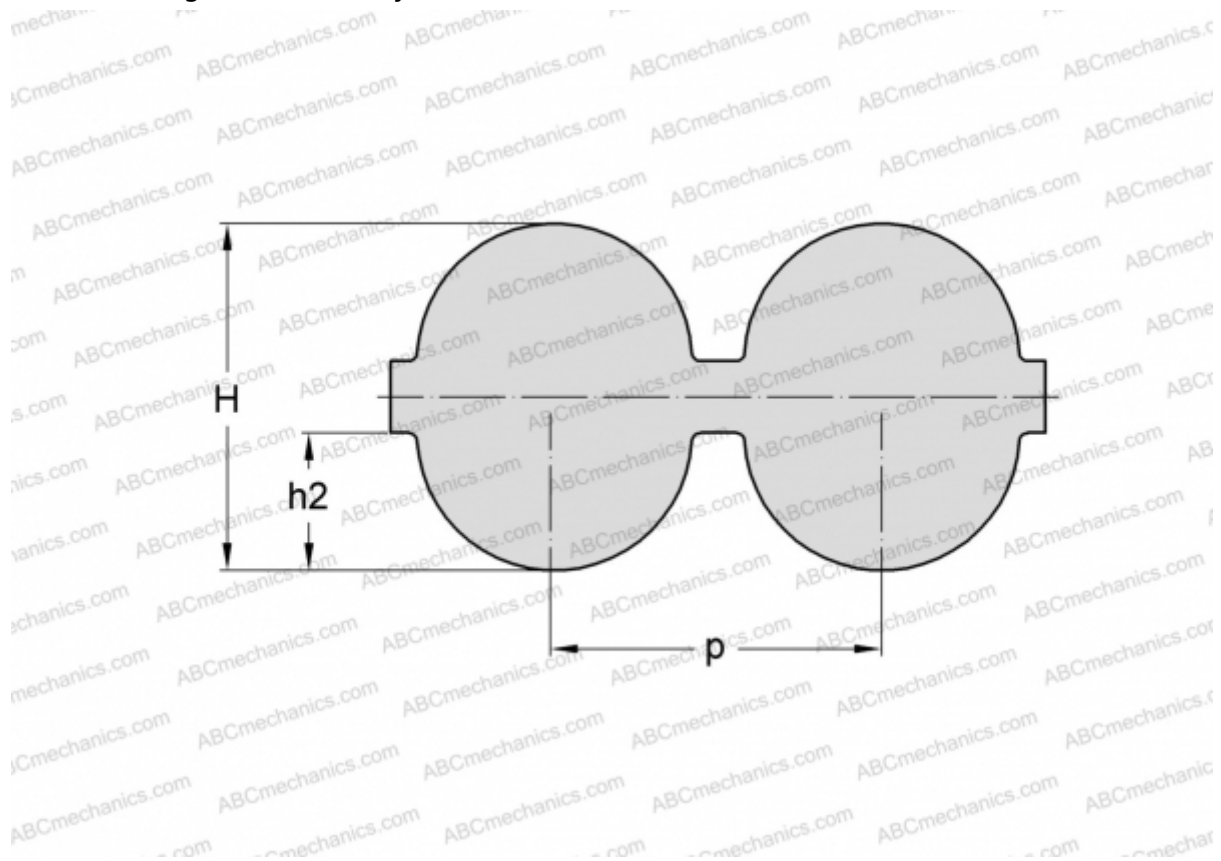

### Technical specification

#### DIMENSIONS, MM

Pitch teeth, p	5,000
Estimated length	830,000
Width, W	15,000
Height, H	5,300
h2	2,100
Number of teeth	166

**MANUFACTURER** [SKF](#)