

PHG DA-1450-5M-25 SKF

Double-sided HiTD belt

TYPE: Classical timing belts, Twoway, HiTD, Section D-5M (SKF)

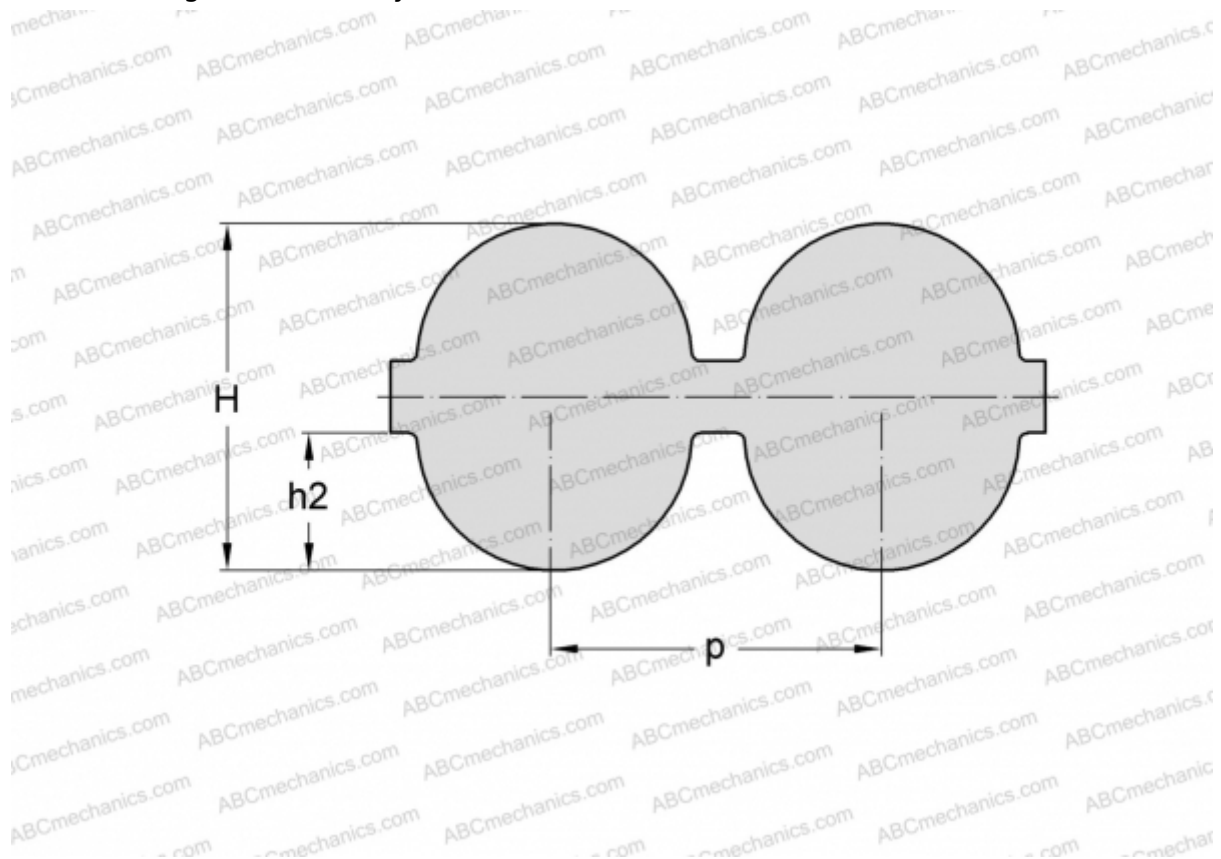

Technical specification

DIMENSIONS, MM

Pitch teeth, p	5,000
Estimated length	1450,000
Width, W	25,000
Height, H	5,300
h2	2,100
Number of teeth	290

MANUFACTURER [SKF](#)