

PHG DA-592-8M-50 SKF

Double-sided HiTD belt

TYPE: Classical timing belts, Twoway, HiTD, Section D-8M (SKF)

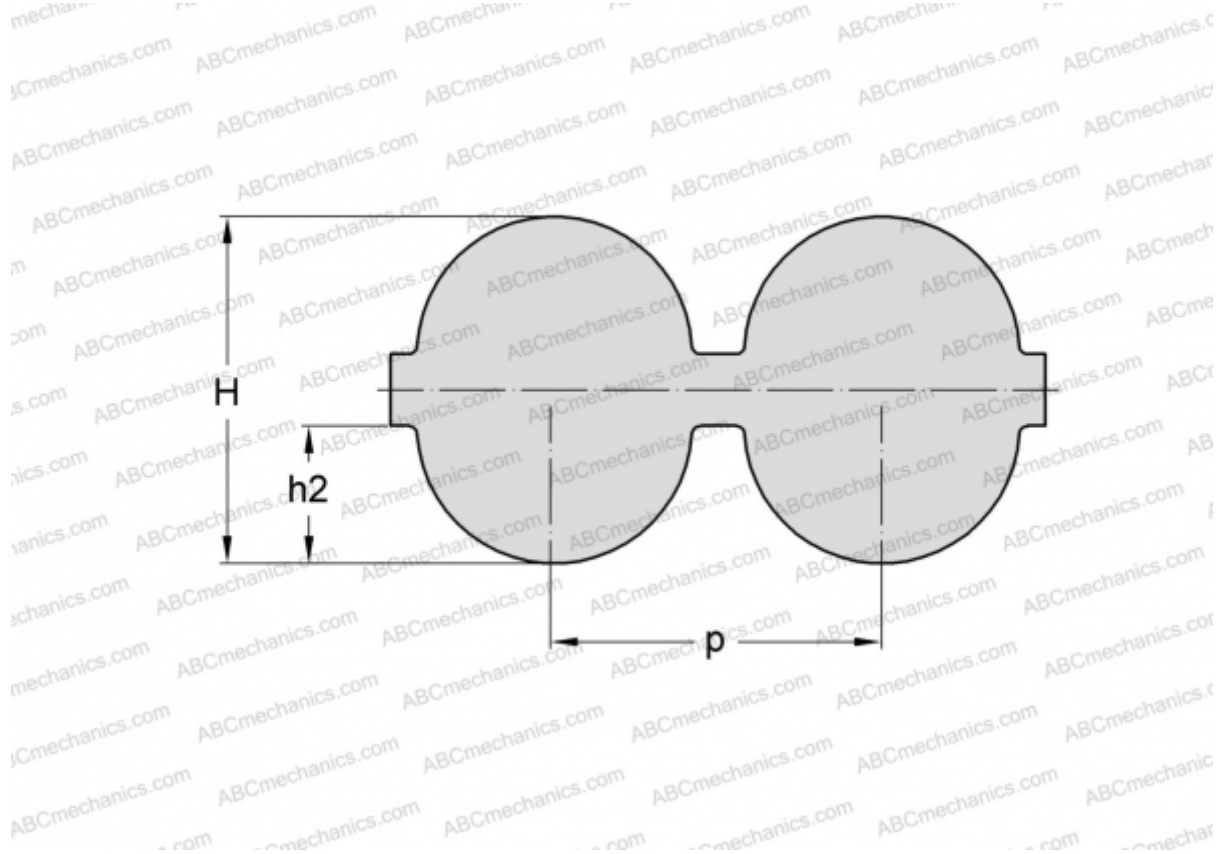

Technical specification

DIMENSIONS, MM

Pitch teeth, p	8,000
Estimated length	592,000
Width, W	50,000
Height, H	8,200
h2	3,400
Number of teeth	74

MANUFACTURER

[SKF](#)