

## PHG DA-648-8M-85 SKF

Double-sided HiTD belt

TYPE: Classical timing belts, Twoway, HiTD, Section D-8M (SKF)

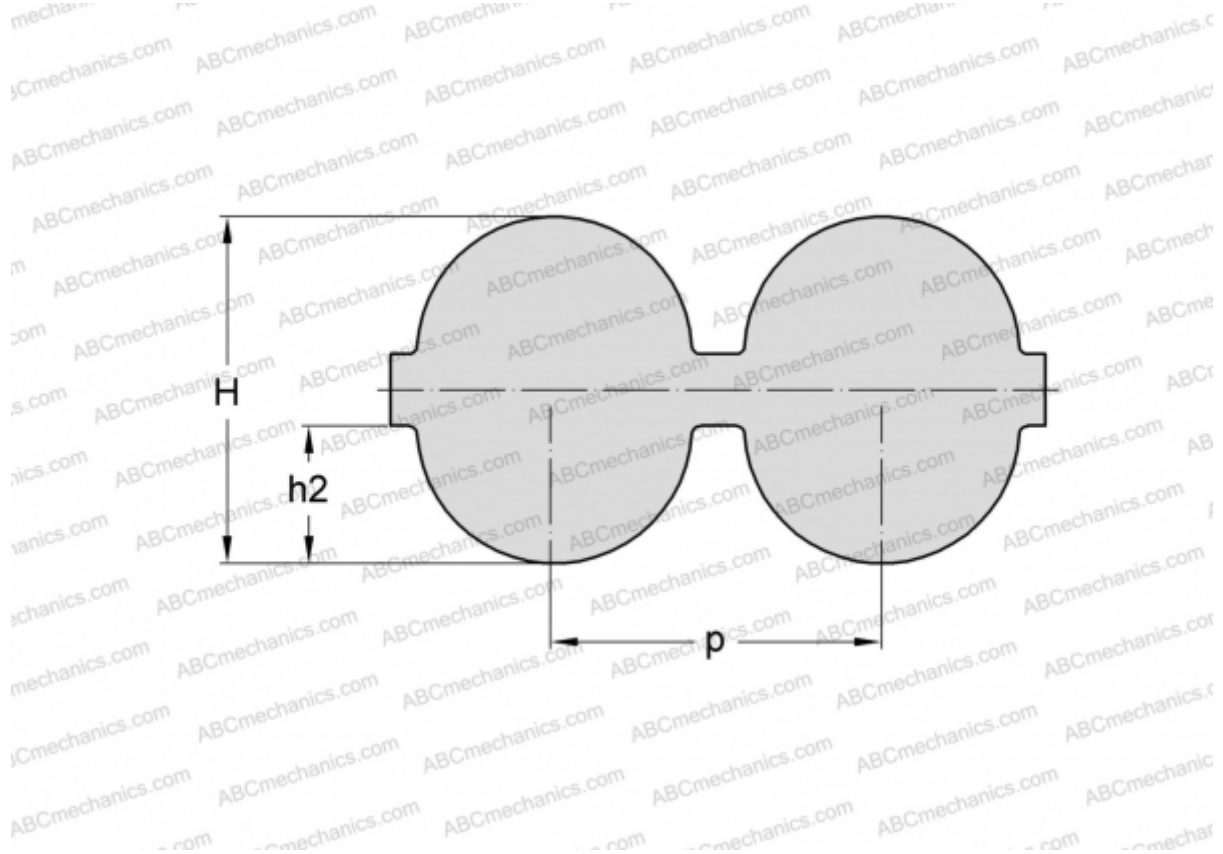

### Technical specification

#### DIMENSIONS, MM

Pitch teeth, p	8,000
Estimated length	648,000
Width, W	85,000
Height, H	8,200
h2	3,400
Number of teeth	81

#### MANUFACTURER

[SKF](#)