

PHG DA-776-8M-30 SKF

Double-sided HiTD belt

TYPE: Classical timing belts, Twoway, HiTD, Section D-8M (SKF)

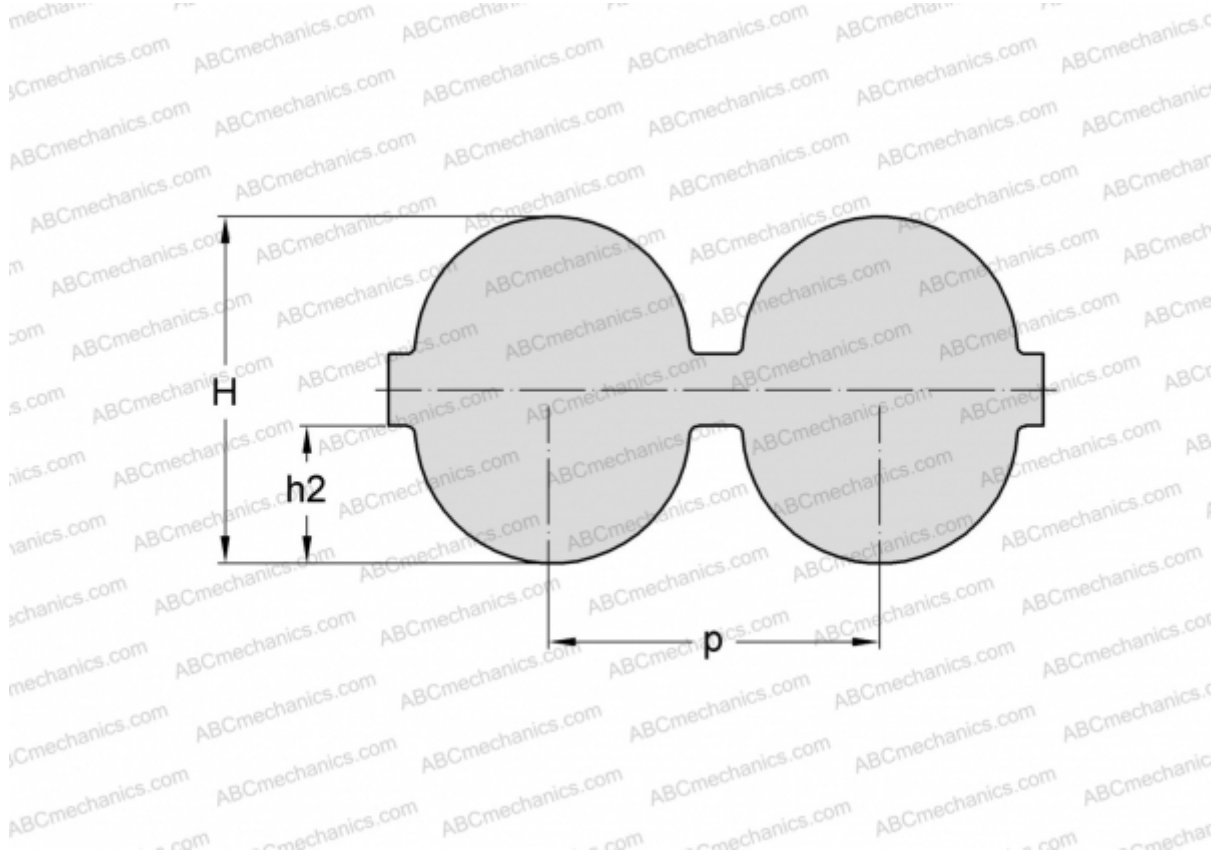

Technical specification

DIMENSIONS, MM

| | |
|------------------|---------|
| Pitch teeth, p | 8,000 |
| Estimated length | 776,000 |
| Width, W | 30,000 |
| Height, H | 8,200 |
| h2 | 3,400 |
| Number of teeth | 97 |

MANUFACTURER

[SKF](#)