

## PHG DA-1392-8M-20 SKF

Double-sided HiTD belt

TYPE: Classical timing belts, Twoway, HiTD, Section D-8M (SKF)

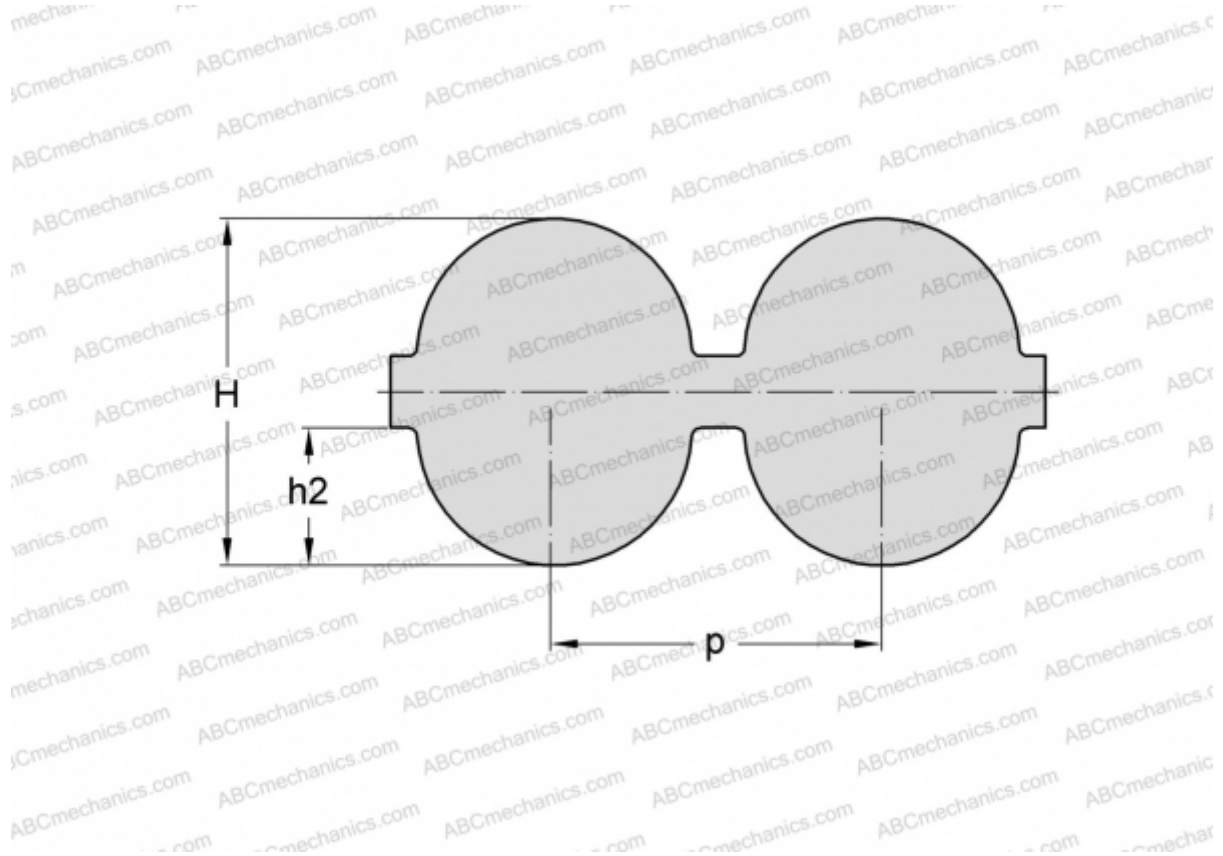

### Technical specification

#### DIMENSIONS, MM

|                  |          |
|------------------|----------|
| Pitch teeth, p   | 8,000    |
| Estimated length | 1392,000 |
| Width, W         | 20,000   |
| Height, H        | 8,200    |
| h2               | 3,400    |
| Number of teeth  | 174      |

#### MANUFACTURER

[SKF](#)