

PHG DA-1784-8M-85 SKF

Double-sided HiTD belt

TYPE: Classical timing belts, Twoway, HiTD, Section D-8M (SKF)

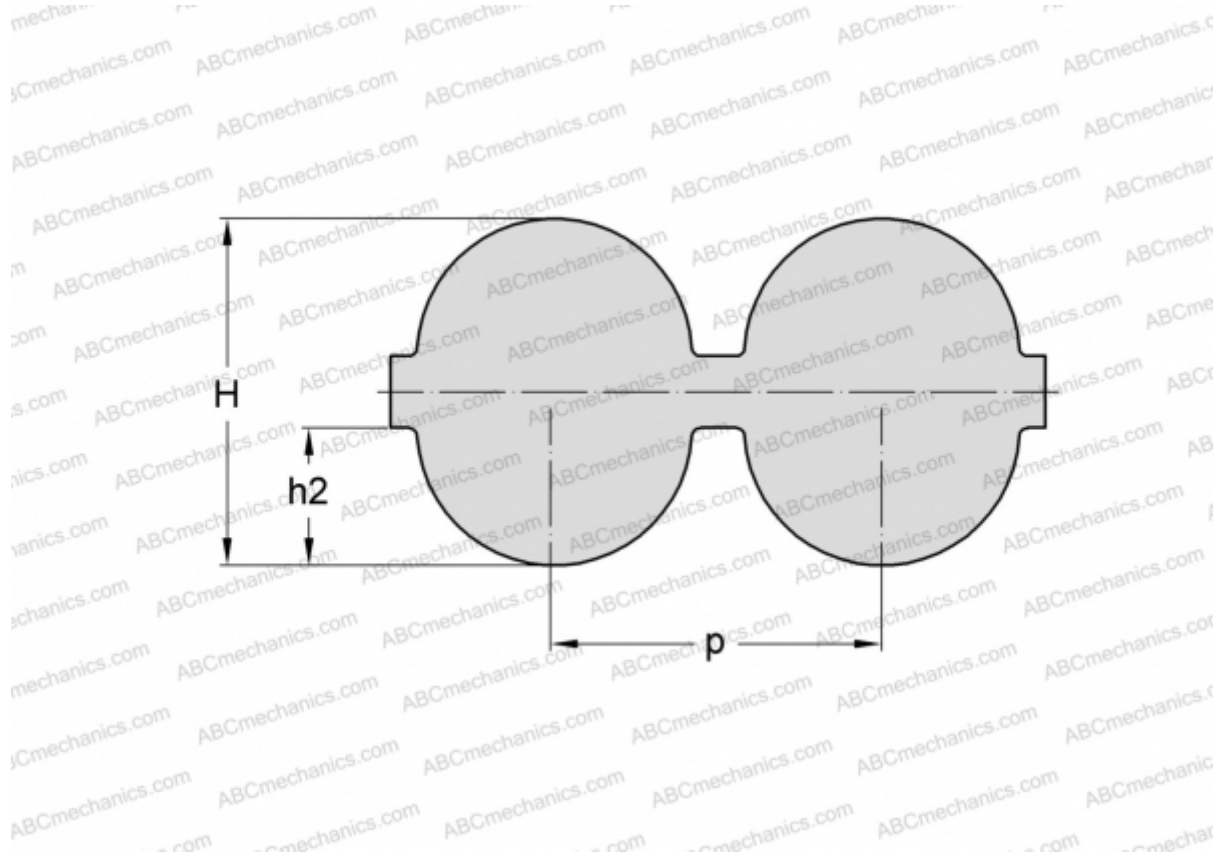

Technical specification

DIMENSIONS, MM

Pitch teeth, p	8,000
Estimated length	1784,000
Width, W	85,000
Height, H	8,200
h2	3,400
Number of teeth	223

MANUFACTURER [SKF](#)