

PHG DA-1946-14M-55 SKF

Double-sided HiTD belt

TYPE: Classical timing belts, Twoway, HiTD, Section D-14M (SKF)

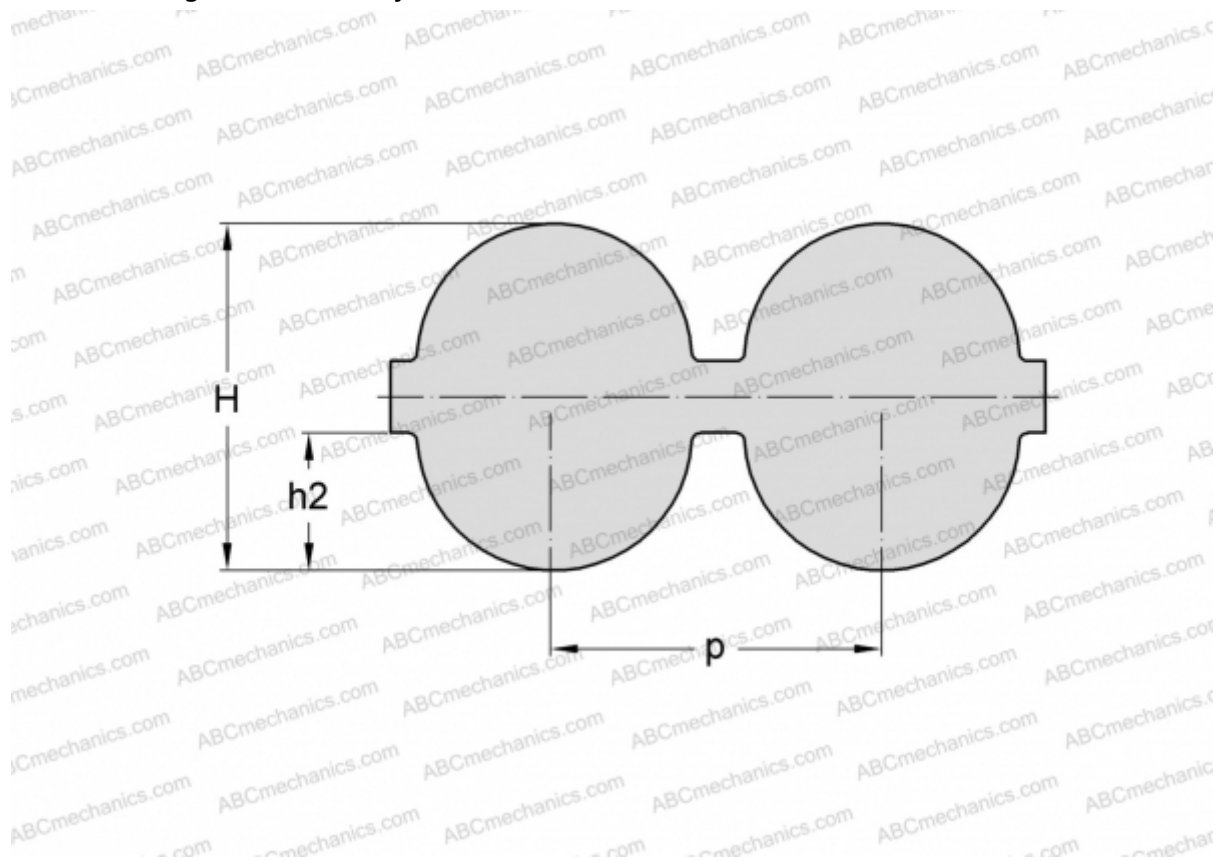

Technical specification

DIMENSIONS, MM

| | |
|------------------|----------|
| Pitch teeth, p | 14,000 |
| Estimated length | 1946,000 |
| Width, W | 55,000 |
| Height, H | 14,800 |
| h2 | 6,000 |
| Number of teeth | 139 |

MANUFACTURER [SKF](#)