

PHG DA-2310-14M-170 SKF

Double-sided HiTD belt

TYPE: Classical timing belts, Twoway, HiTD, Section D-14M (SKF)

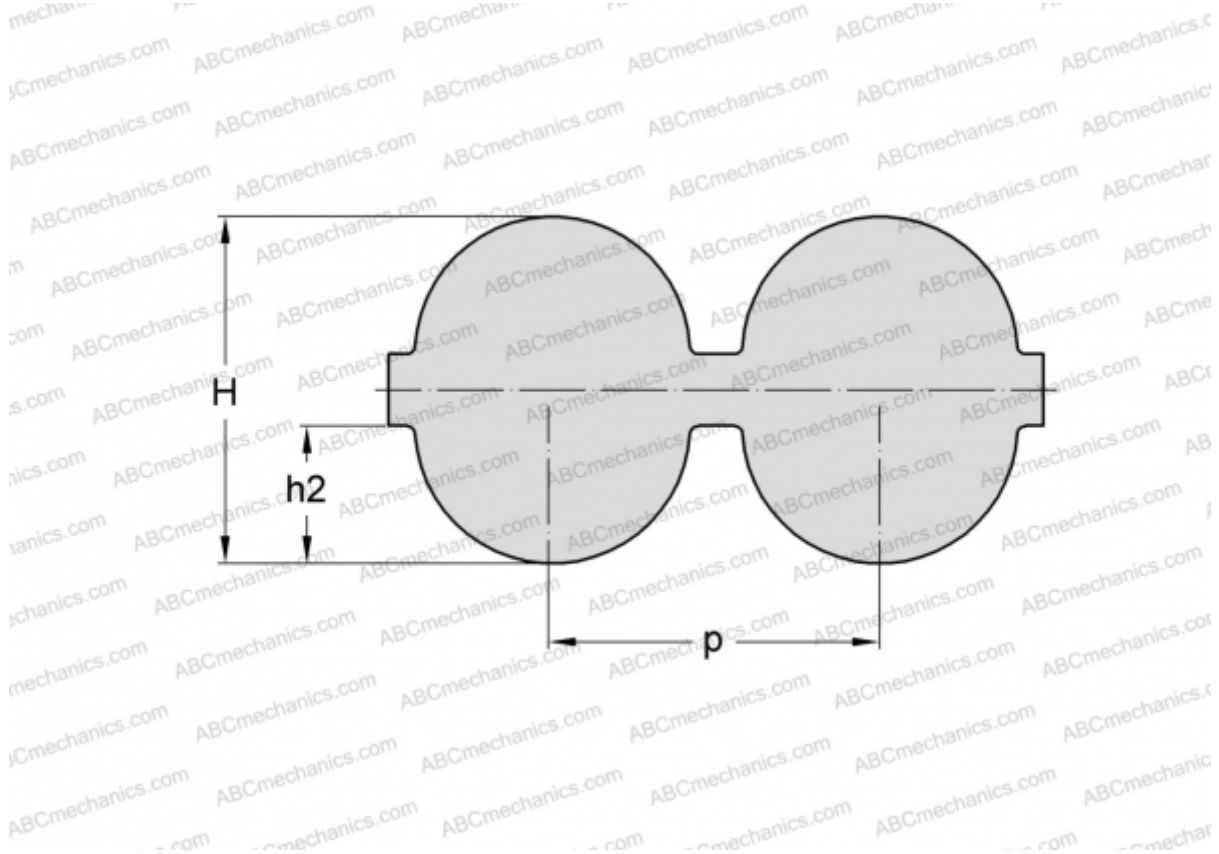

Technical specification

DIMENSIONS, MM

Pitch teeth, p	14,000
Estimated length	2310,000
Width, W	170,000
Height, H	4,800
h2	6,000
Number of teeth	165

MANUFACTURER [SKF](#)