

## PHG DA-3304-14M-115 SKF

Double-sided HiTD belt

TYPE: Classical timing belts, Twoway, HiTD, Section D-14M (SKF)

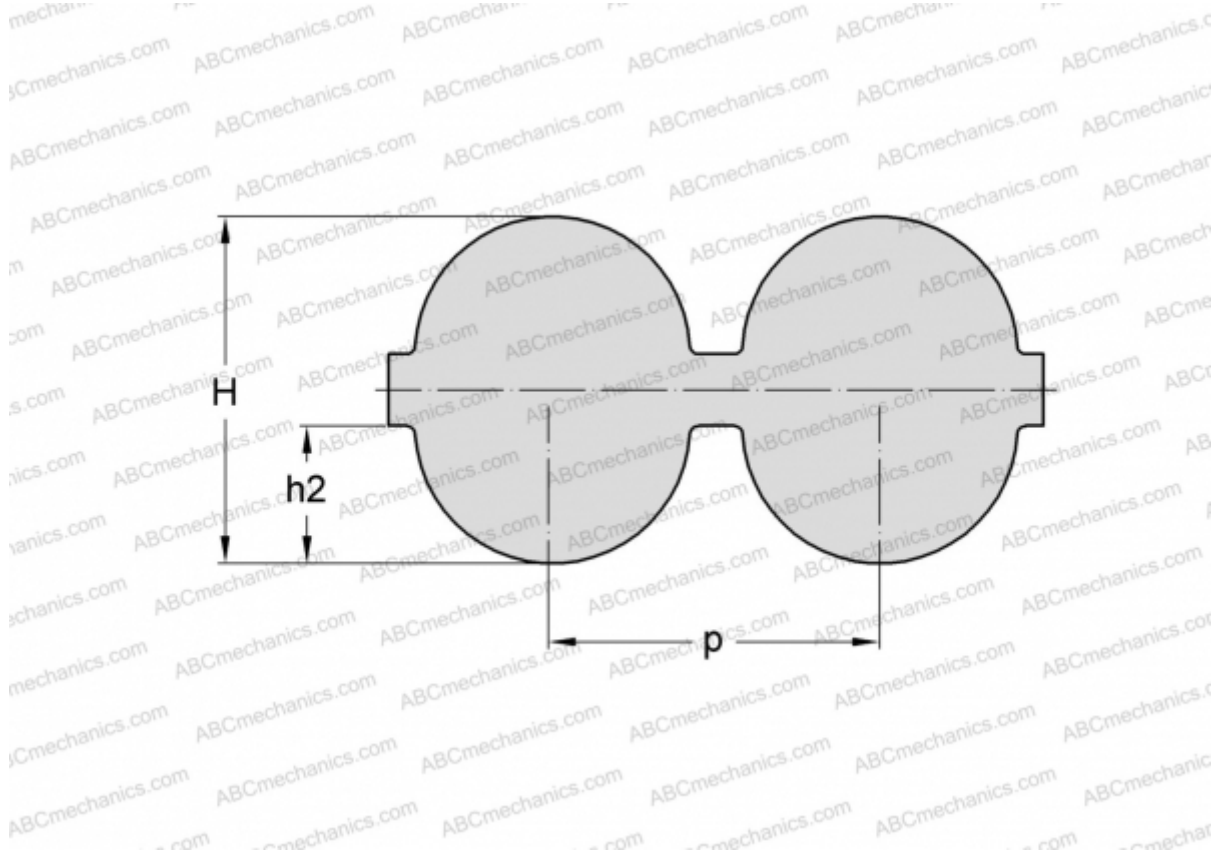

### Technical specification

#### DIMENSIONS, MM

Pitch teeth, p	14,000
Estimated length	3304,000
Width, W	115,000
Height, H	14,800
h2	6,000
Number of teeth	236

**MANUFACTURER** [SKF](#)