

PHG DA-3850-14M-55 SKF

Double-sided HiTD belt

TYPE: Classical timing belts, Twoway, HiTD, Section D-14M (SKF)

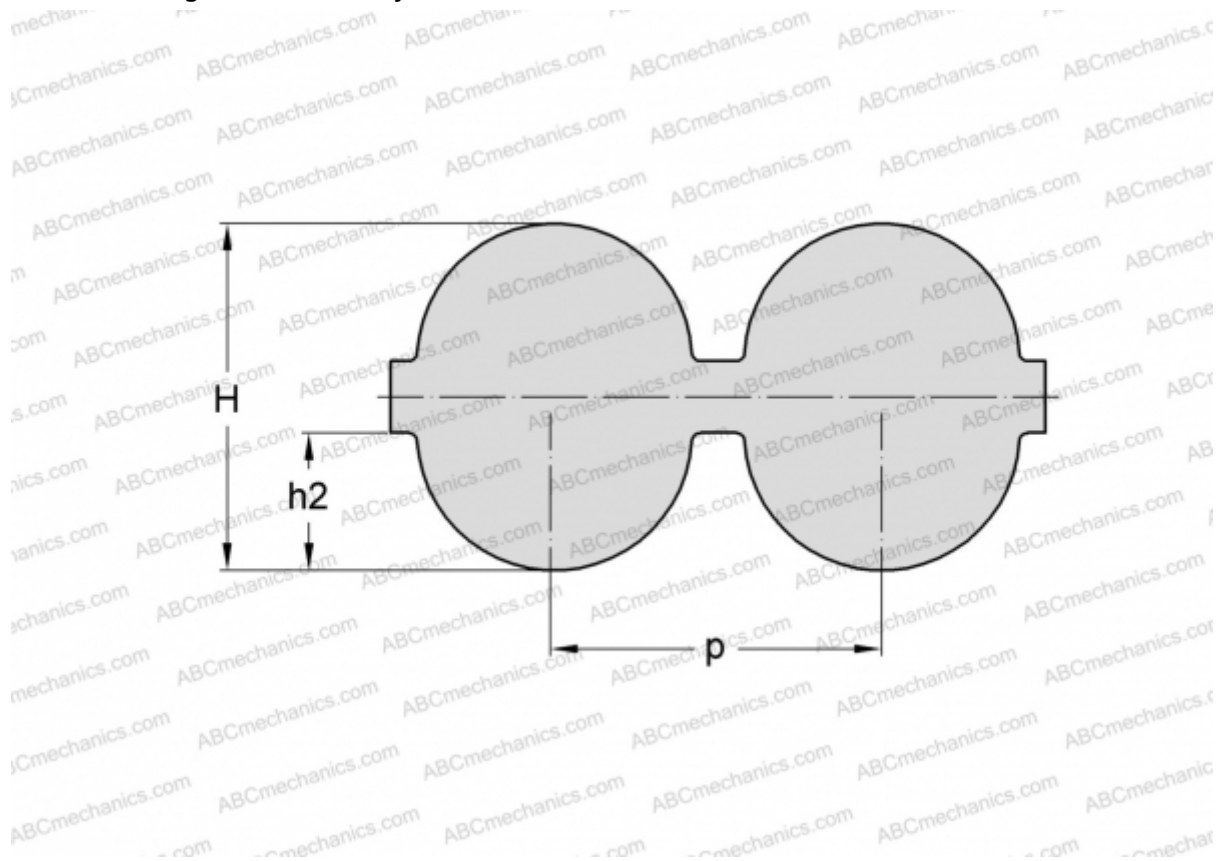

Technical specification

DIMENSIONS, MM

Pitch teeth, p	14,000
Estimated length	3850,000
Width, W	55,000
Height, H	14,800
h2	6,000
Number of teeth	275

MANUFACTURER

[SKF](#)