

## PHG DA-4760-14M-170 SKF

Double-sided HiTD belt

TYPE: Classical timing belts, Twoway, HiTD, Section D-14M (SKF)

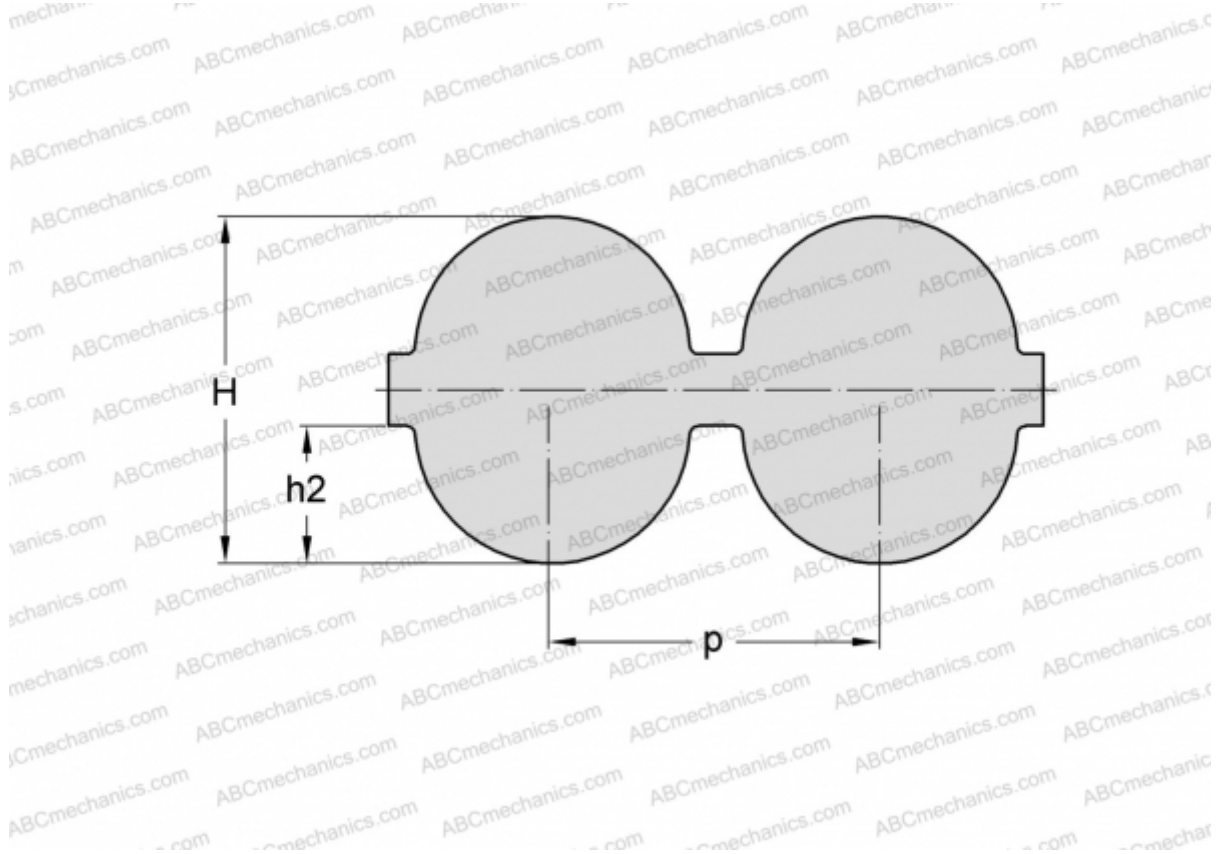

### Technical specification

#### DIMENSIONS, MM

Pitch teeth, p	14,000
Estimated length	4760,000
Width, W	170,000
Height, H	14,800
h2	6,000
Number of teeth	340

**MANUFACTURER** [SKF](#)