

PHG DA-5040-14M-85 SKF

Double-sided HiTD belt

TYPE: Classical timing belts, Twoway, HiTD, Section D-14M (SKF)

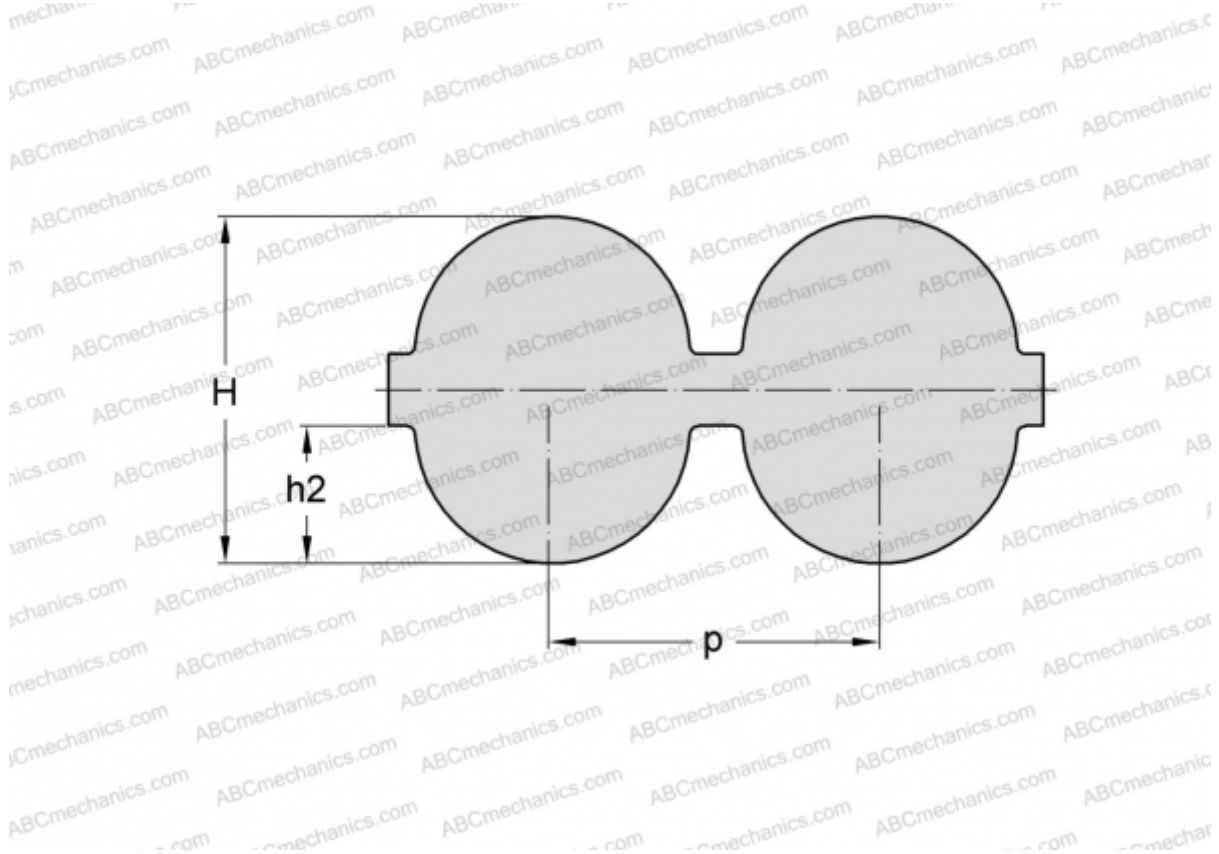

Technical specification

DIMENSIONS, MM

Pitch teeth, p	14,000
Estimated length	5040,000
Width, W	85,000
Height, H	14,800
h2	6,000
Number of teeth	360

MANUFACTURER

[SKF](#)