

## PHG DS5M-520-25 SKF

Double-sided HiTD belt

TYPE: Classical timing belts, Twoway, Super Torque, Section DS5M (SKF)

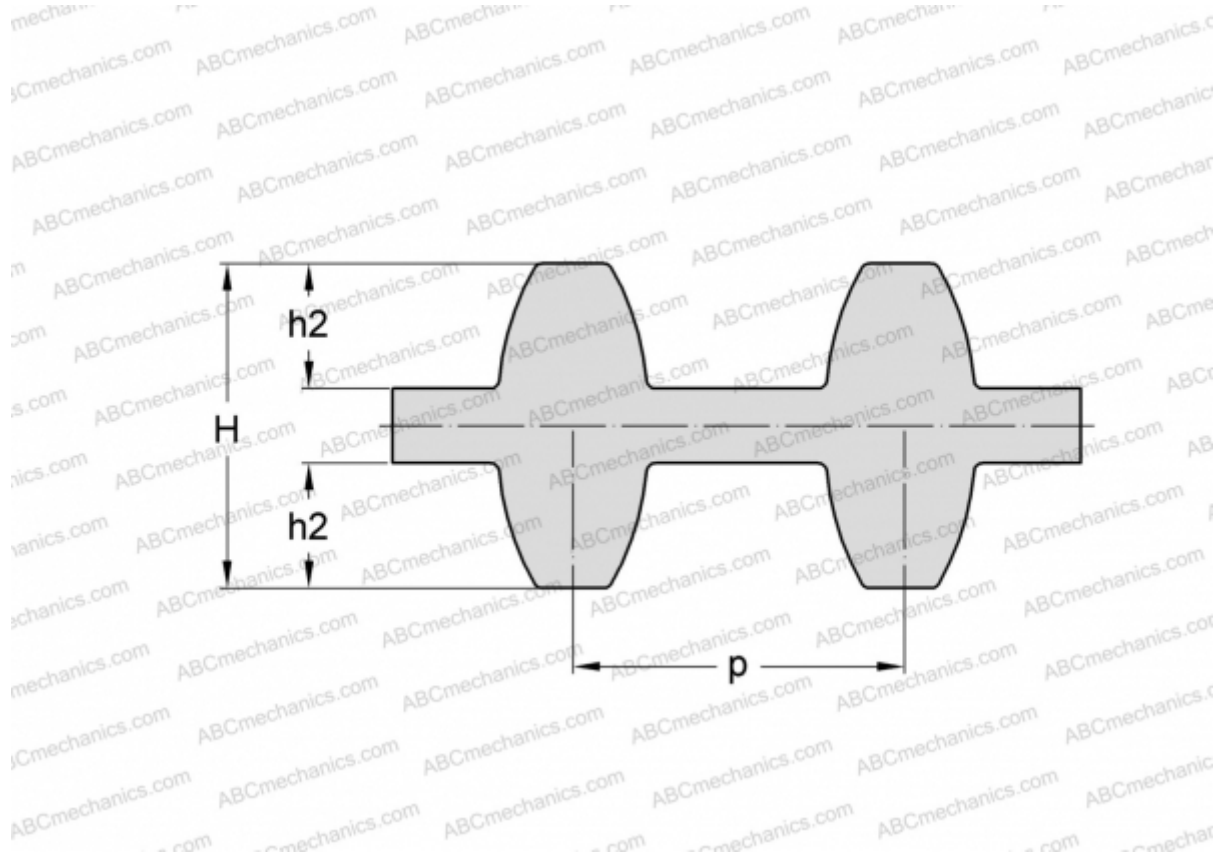

### Technical specification

#### DIMENSIONS, MM

Pitch teeth, p	5,000
Estimated length	520,000
Width, W	25,000
Height, H	4,960
h2	1,910
Number of teeth	104

#### MANUFACTURER

[SKF](#)