

PHG DS5M-900-15 SKF

Double-sided HiTD belt

TYPE: Classical timing belts, Twoway, Super Torque, Section DS5M (SKF)

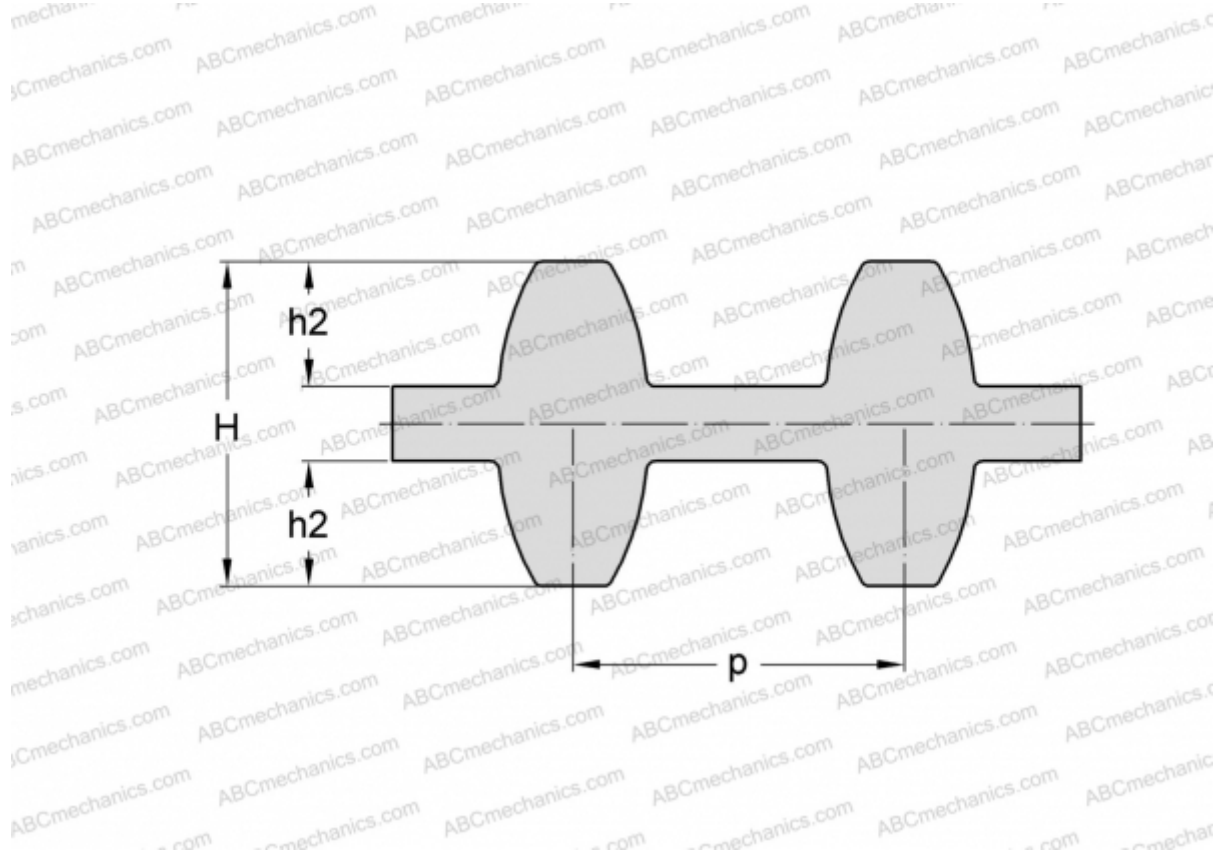

Technical specification

DIMENSIONS, MM

Pitch teeth, p	5,000
Estimated length	900,000
Width, W	15,000
Height, H	4,960
h2	1,910
Number of teeth	180

MANUFACTURER

[SKF](#)