

## PHG DS8M-1648-20 SKF

Double-sided HiTD belt

TYPE: Classical timing belts, Twoway, Super Torque, Section DS8M (SKF)

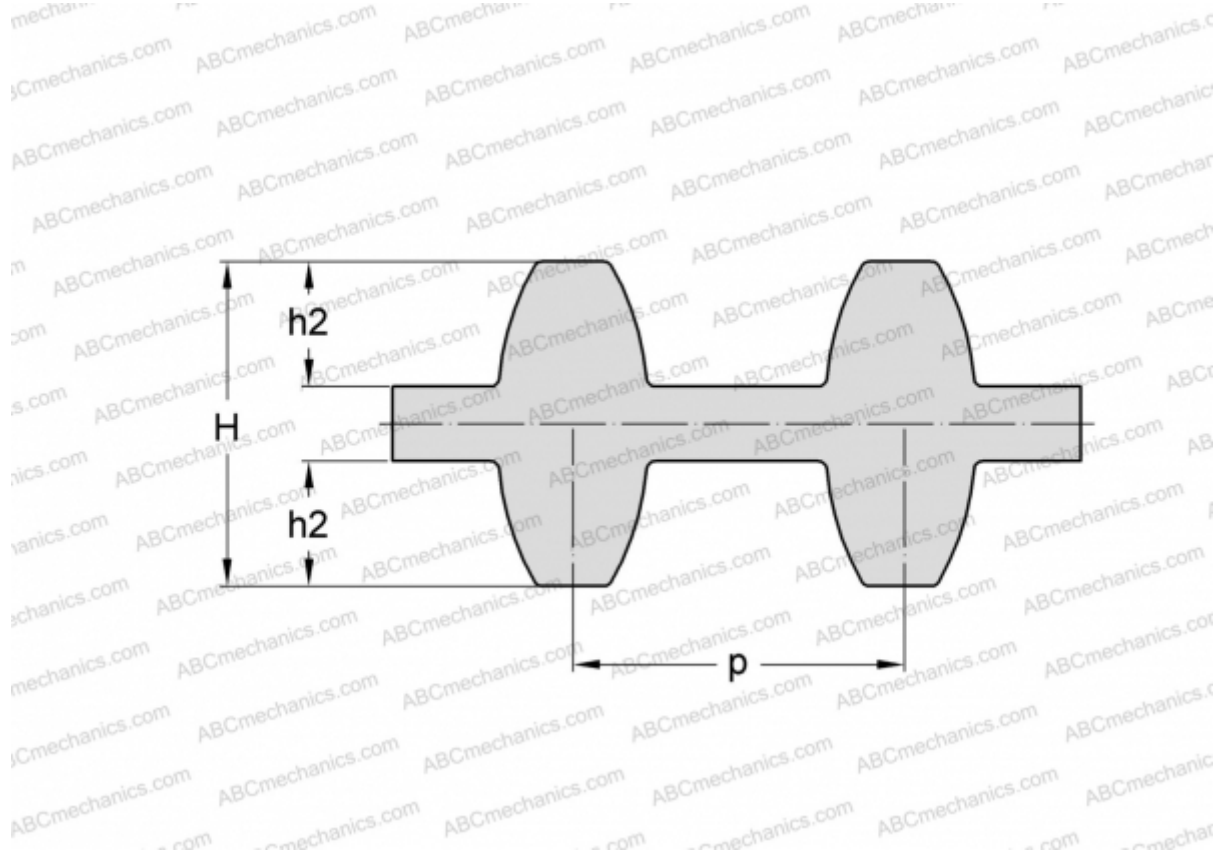

### Technical specification

#### DIMENSIONS, MM

Pitch teeth, p	8,000
Estimated length	1648,000
Width, W	20,000
Height, H	7,470
h2	3,050
Number of teeth	206

#### MANUFACTURER

[SKF](#)