

PHG DS8M-1776-85 SKF

Double-sided HiTD belt

TYPE: Classical timing belts, Twoway, Super Torque, Section DS8M (SKF)

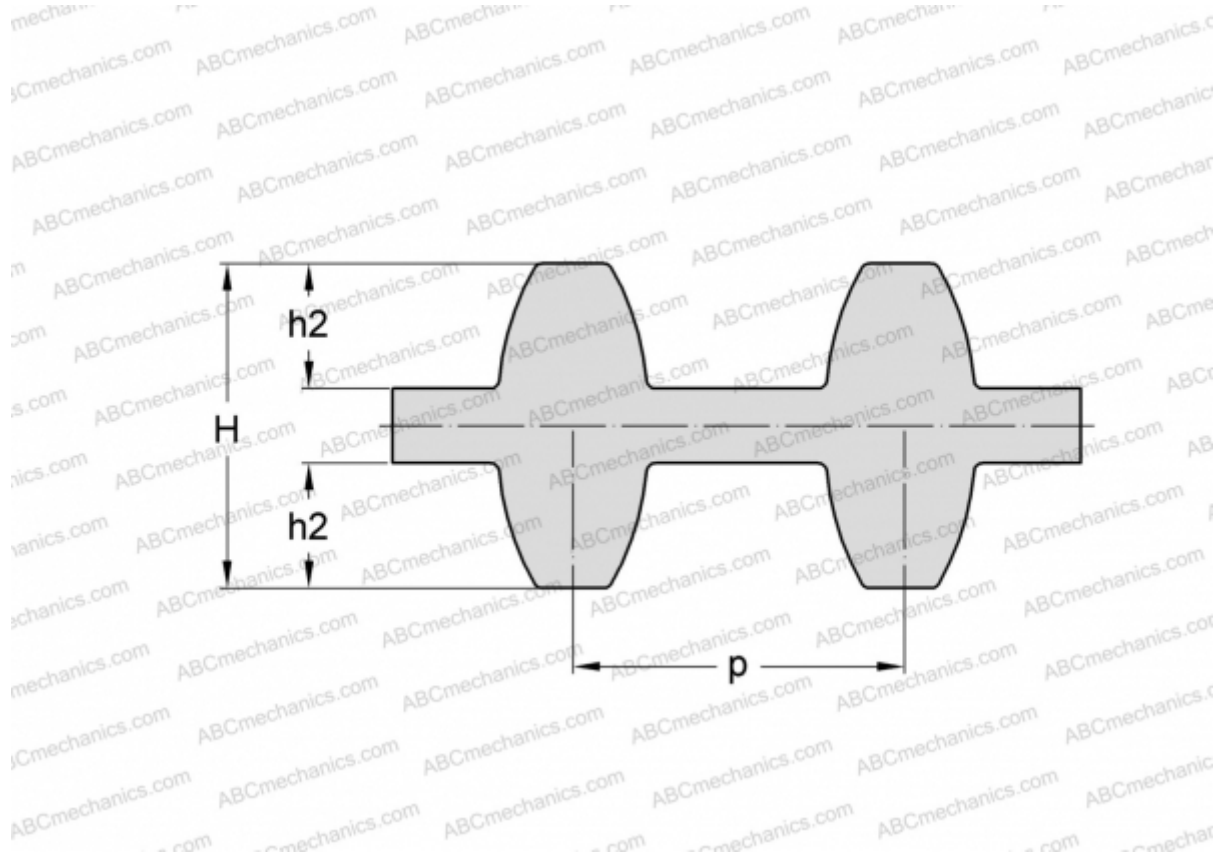

Technical specification

DIMENSIONS, MM

Pitch teeth, p	8,000
Estimated length	1776,000
Width, W	85,000
Height, H	7,470
h2	3,050
Number of teeth	222

MANUFACTURER [SKF](#)