

PHG DS8M-3720-30 SKF

Double-sided HiTD belt

TYPE: Classical timing belts, Twoway, Super Torque, Section DS8M (SKF)

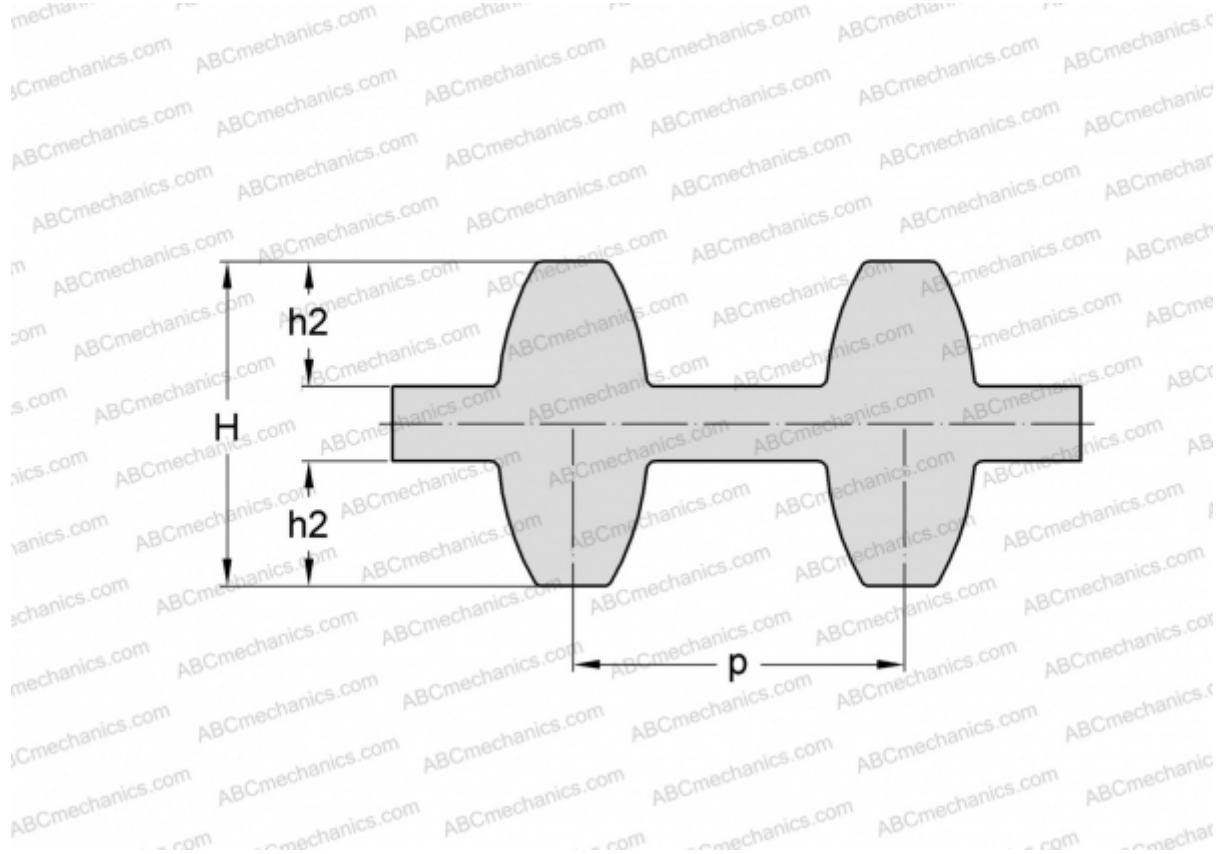

Technical specification

DIMENSIONS, MM

Pitch teeth, p	8,000
Estimated length	3720,000
Width, W	30,000
Height, H	7,470
h2	3,050
Number of teeth	465

MANUFACTURER

[SKF](#)