

## PHG DS8M-5696-85 SKF

Double-sided HiTD belt

TYPE: Classical timing belts, Twoway, Super Torque, Section DS8M (SKF)

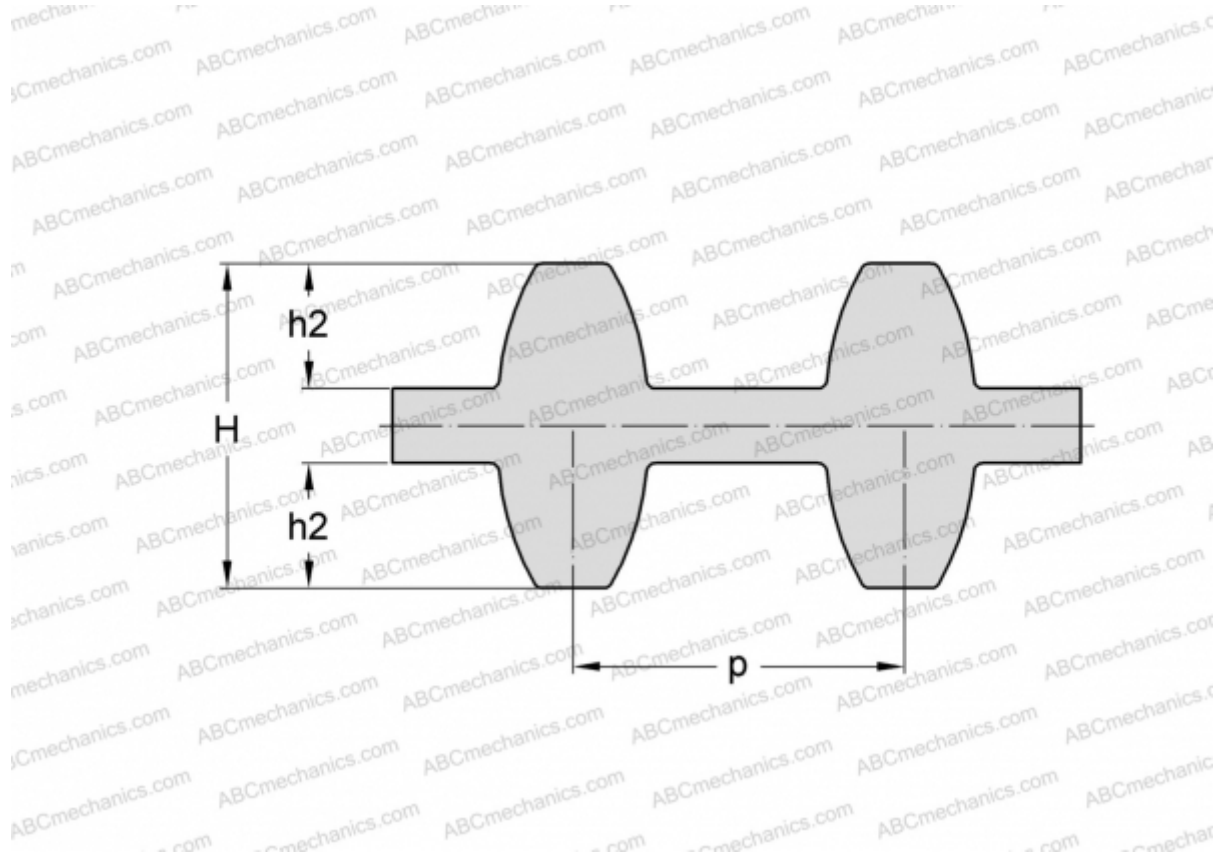

### Technical specification

#### DIMENSIONS, MM

Pitch teeth, p	8,000
Estimated length	5696,000
Width, W	85,000
Height, H	7,470
h2	3,050
Number of teeth	712

#### MANUFACTURER

[SKF](#)