

PHG Z15 SKF

Wrapped classical belt

TYPE: V- belts, Classical, Wrapped, Section 10/Z (SKF)

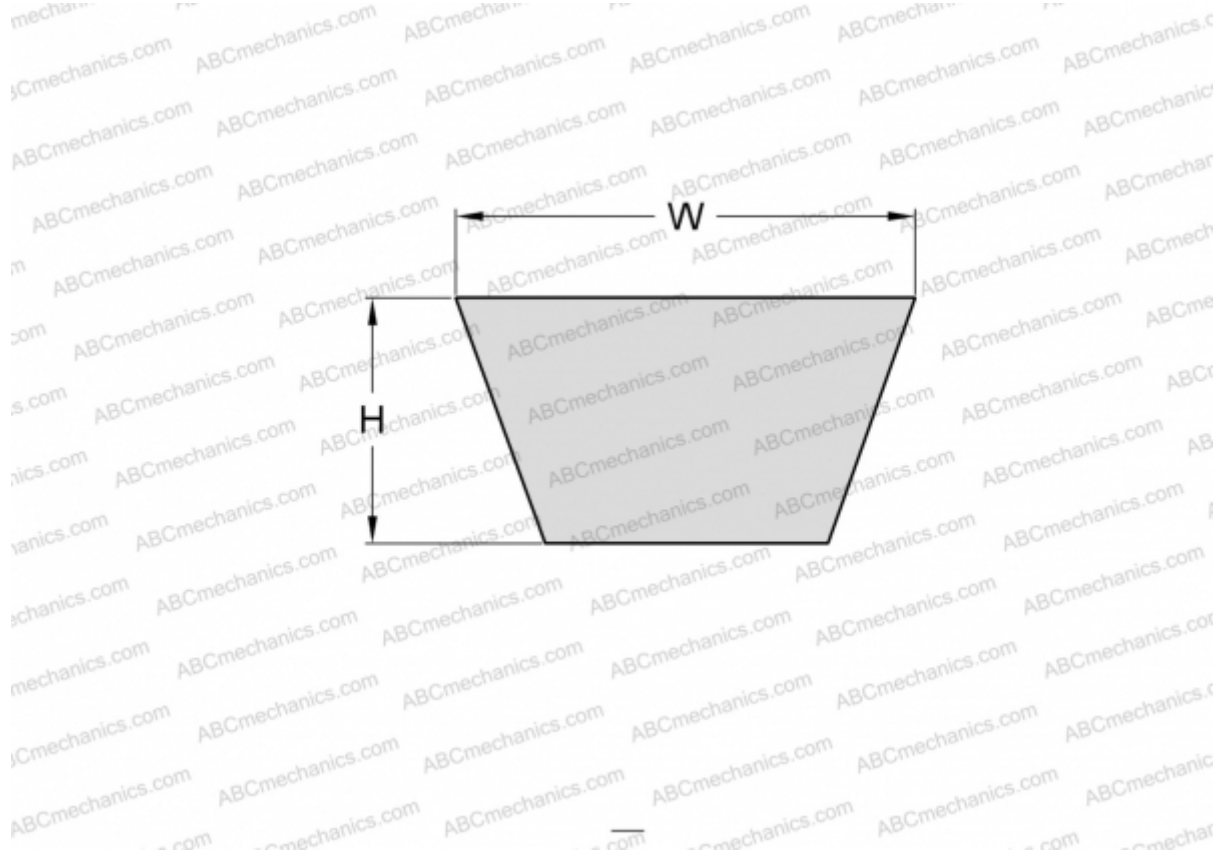

Technical specification

DIMENSIONS, MM

Estimated length	395,000
Inner length	381,000
Width, W	10,000
Height, H	6,000

MANUFACTURER

[SKF](#)