

## PHG Z23 SKF

Wrapped classical belt

TYPE: V- belts, Classical, Wrapped, Section 10/Z (SKF)

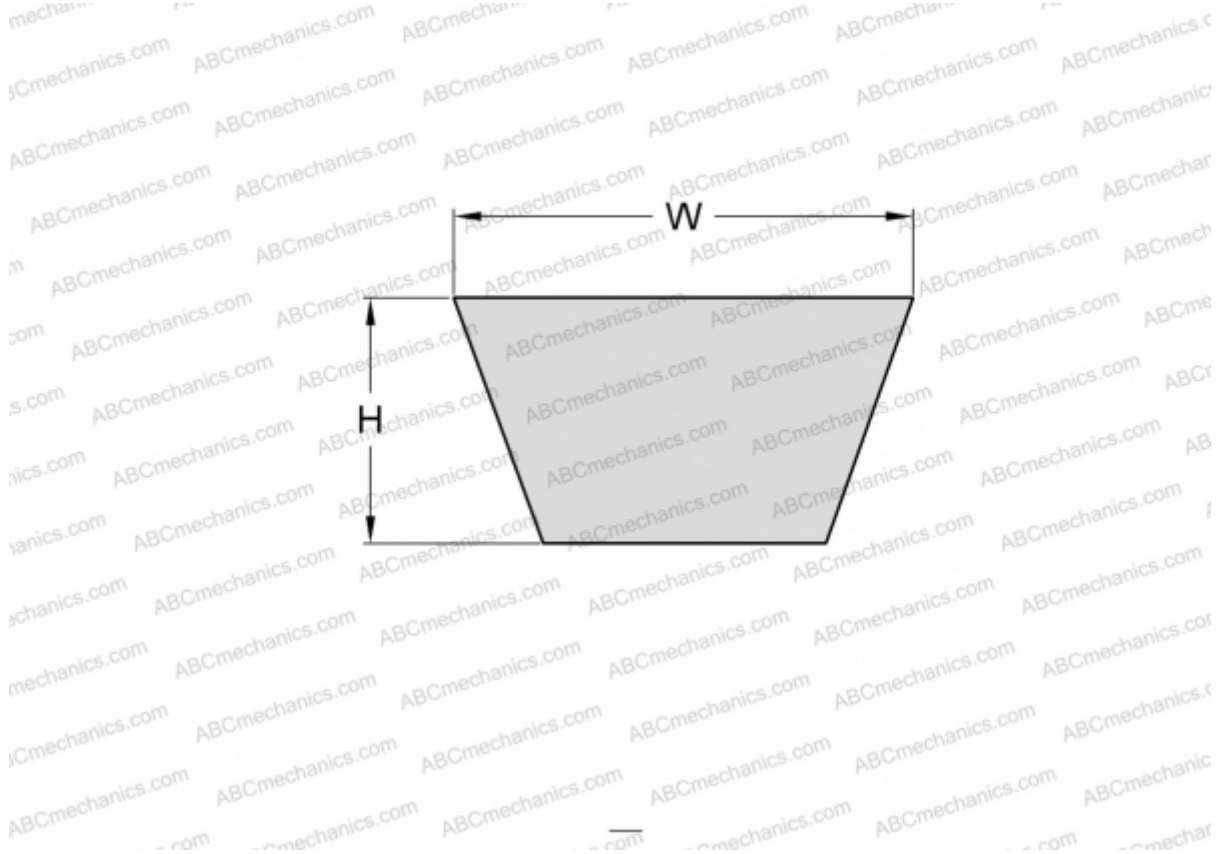

### Technical specification

#### DIMENSIONS, MM

Estimated length	600,000
Inner length	584,000
Width, W	10,000
Height, H	6,000

#### MANUFACTURER

[SKF](#)