

## PHG A59 SKF

Wrapped classical belt

TYPE: V- belts, Classical, Wrapped, Section 13/A (SKF)

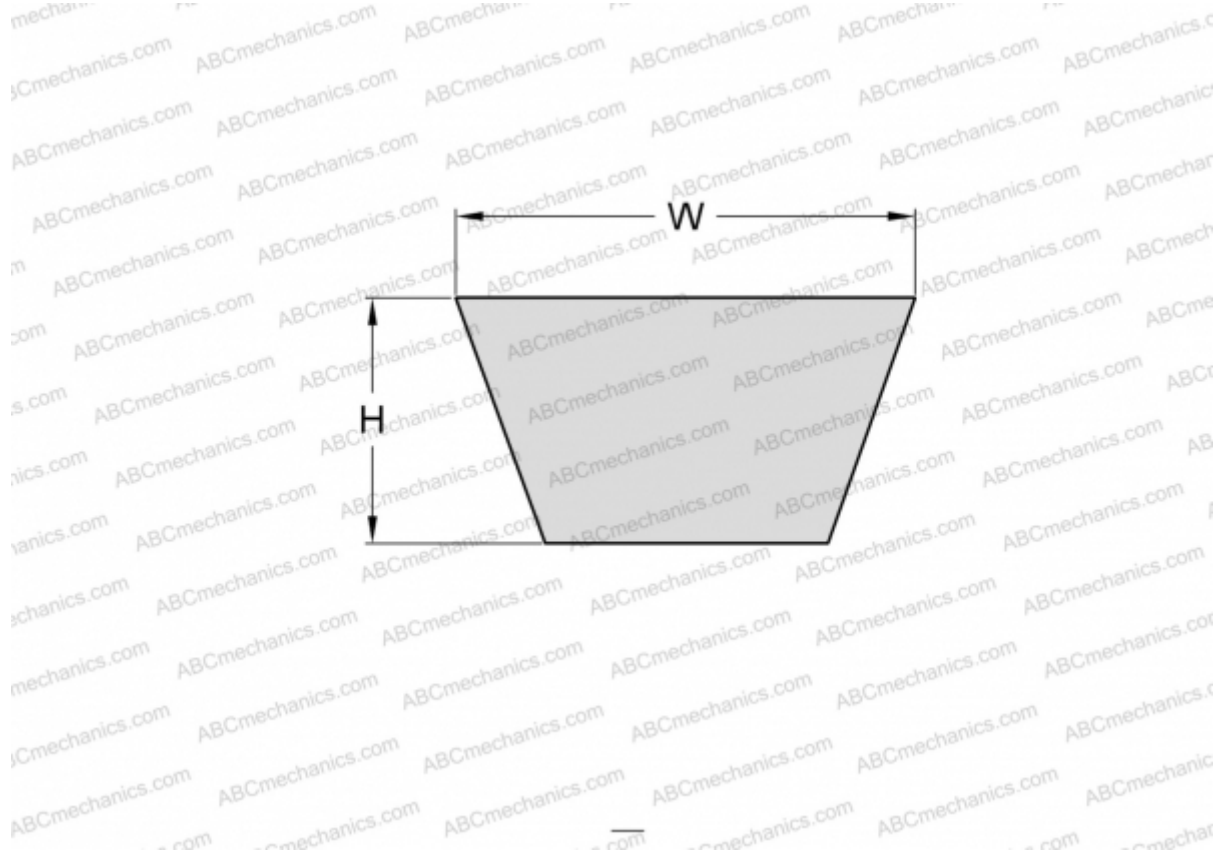

### Technical specification

#### DIMENSIONS, MM

Estimated length	1530,000
Inner length	1499,000
Width, W	13,000
Height, H	8,000

#### MANUFACTURER

[SKF](#)