

PHG A87 SKF

Wrapped classical belt

TYPE: V- belts, Classical, Wrapped, Section 13/A (SKF)

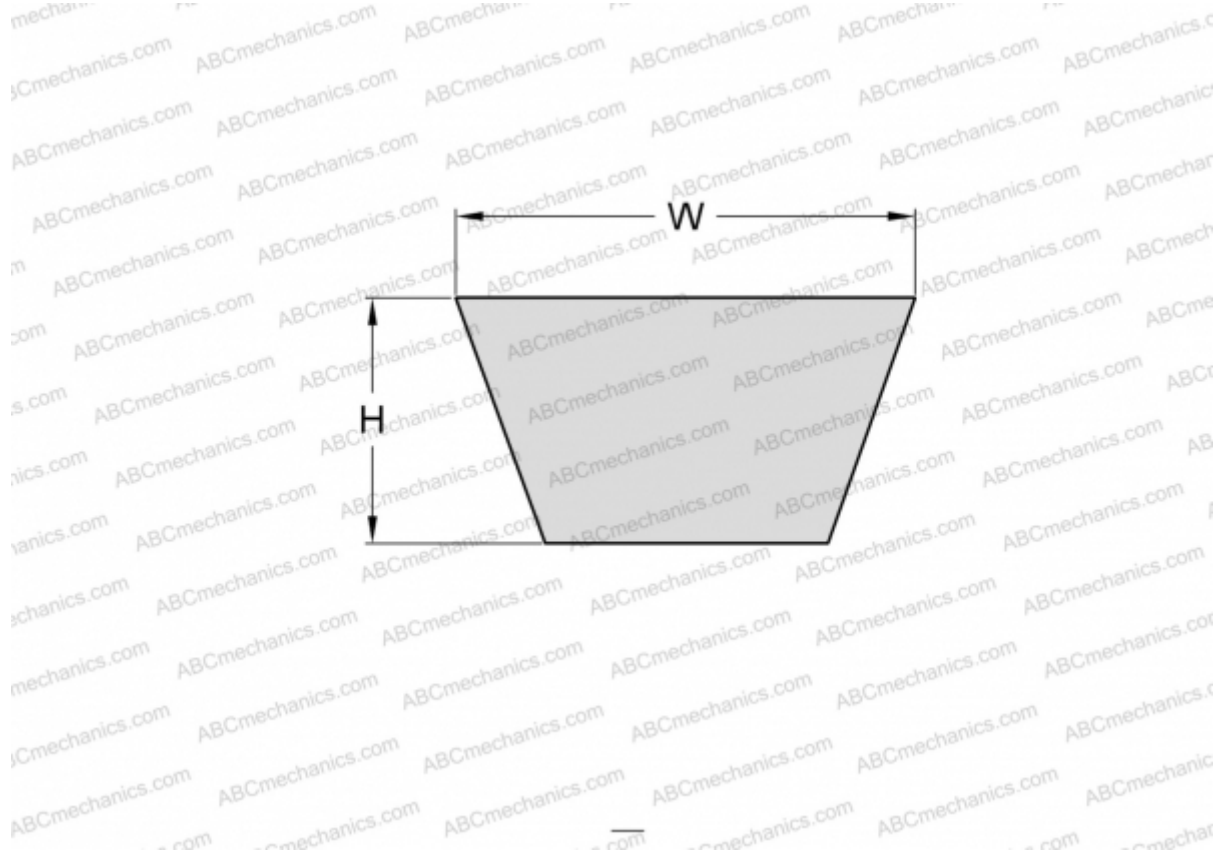

Technical specification

DIMENSIONS, MM

Estimated length	2240,000
Inner length	2210,000
Width, W	13,000
Height, H	8,000

MANUFACTURER [SKF](#)