

## PHG B70 SKF

Wrapped classical belt

TYPE: V- belts, Classical, Wrapped, Section 17/B (SKF)

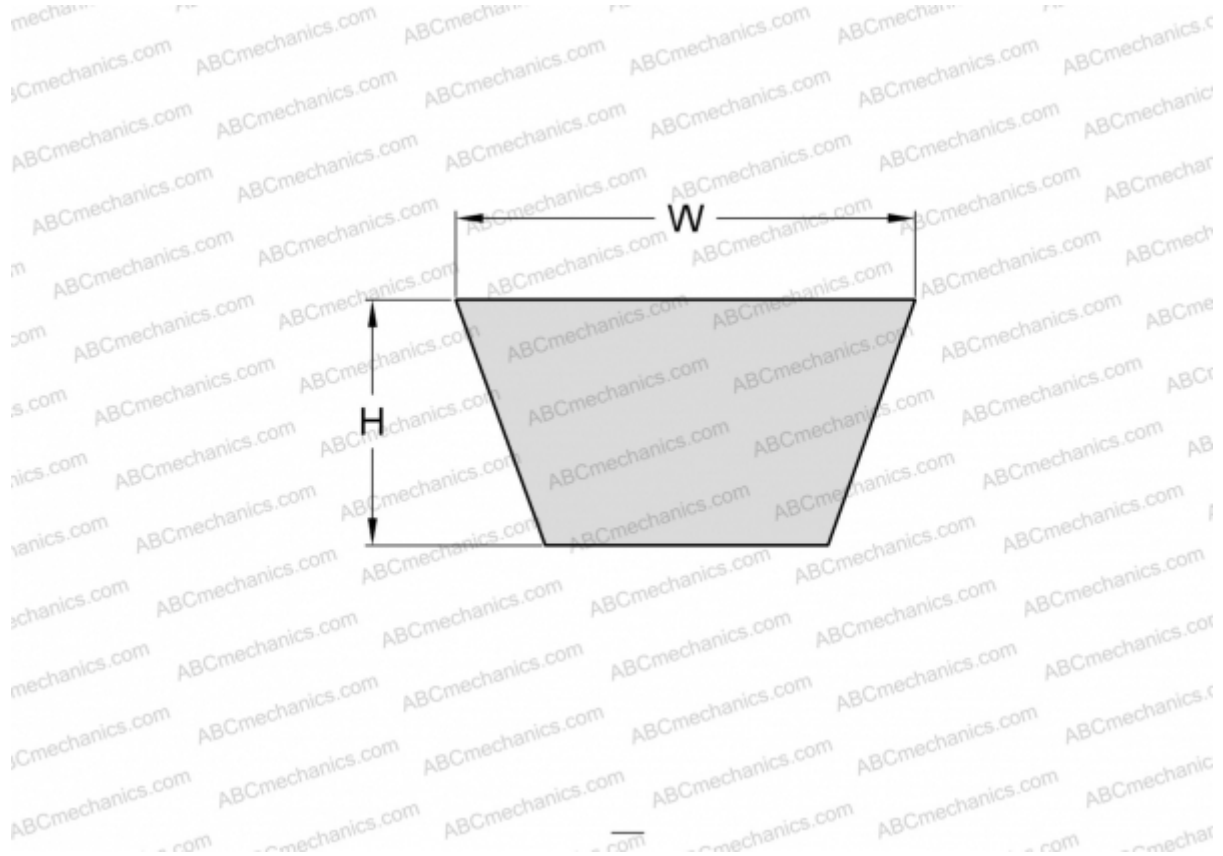

### Technical specification

#### DIMENSIONS, MM

Estimated length	1820,000
Inner length	1778,000
Width, W	17,000
Height, H	11,000

#### MANUFACTURER

[SKF](#)