

PHG B75 SKF

Wrapped classical belt

TYPE: V- belts, Classical, Wrapped, Section 17/B (SKF)

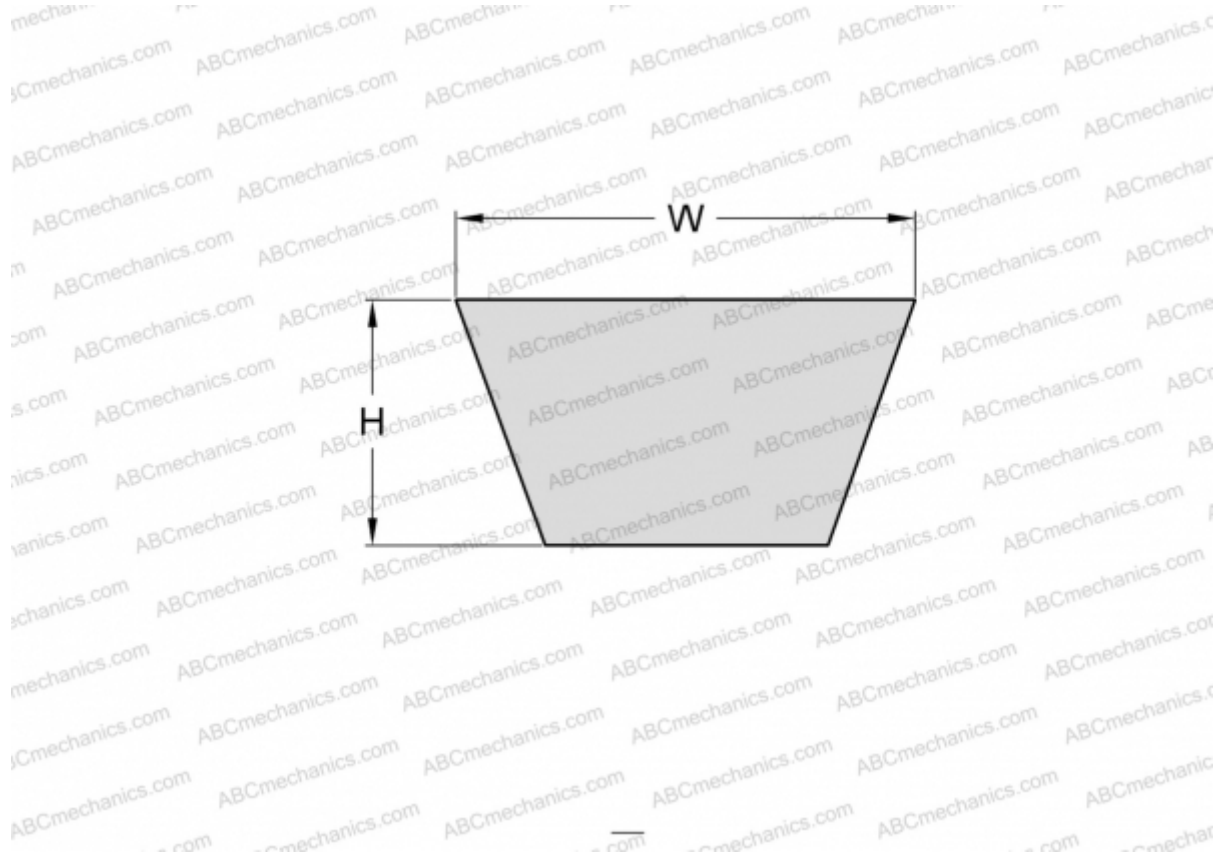

Technical specification

DIMENSIONS, MM

Estimated length	1950,000
Inner length	1905,000
Width, W	17,000
Height, H	11,000

MANUFACTURER

[SKF](#)