

PHG B98 SKF

Wrapped classical belt

TYPE: V- belts, Classical, Wrapped, Section 17/B (SKF)

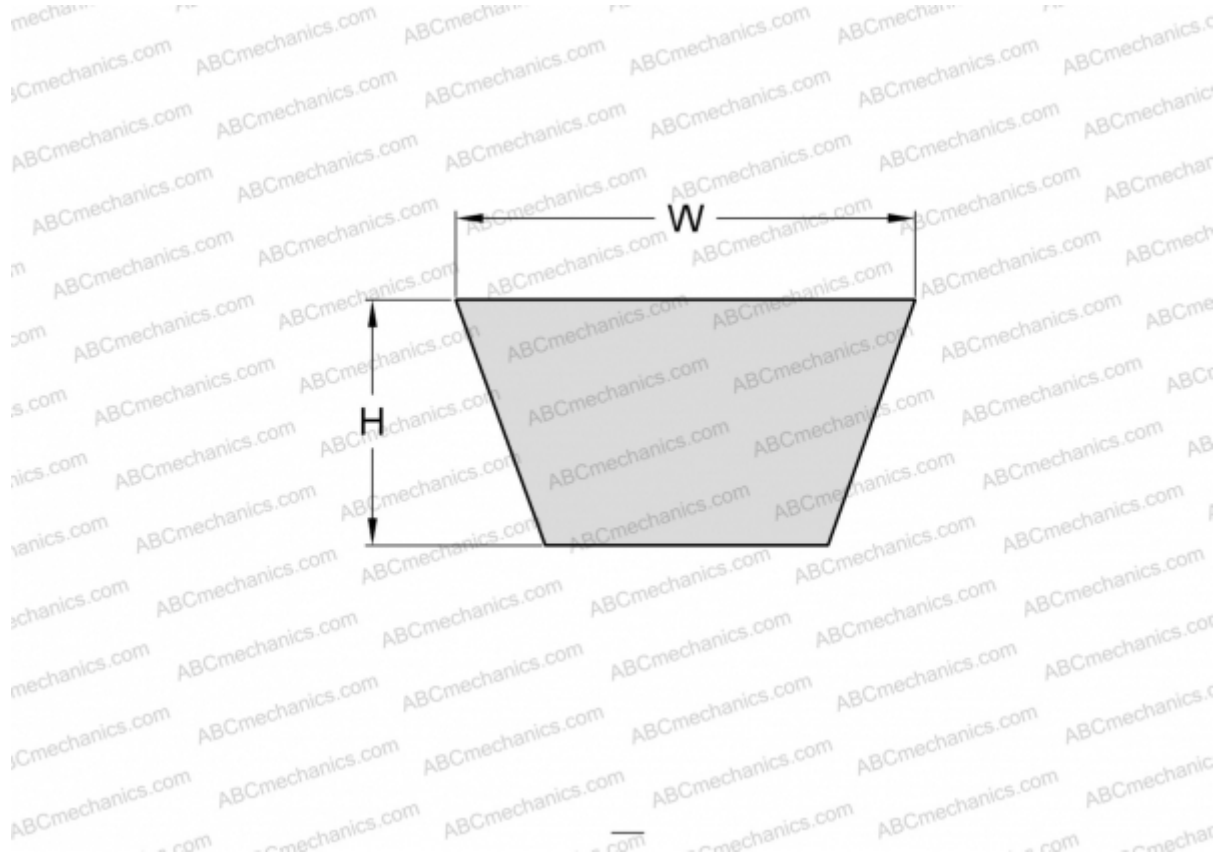

Technical specification

DIMENSIONS, MM

| | |
|------------------|----------|
| Estimated length | 2530,000 |
| Inner length | 2489,000 |
| Width, W | 17,000 |
| Height, H | 11,000 |

MANUFACTURER

[SKF](#)