

PHG B138 SKF

Wrapped classical belt

TYPE: V- belts, Classical, Wrapped, Section 17/B (SKF)

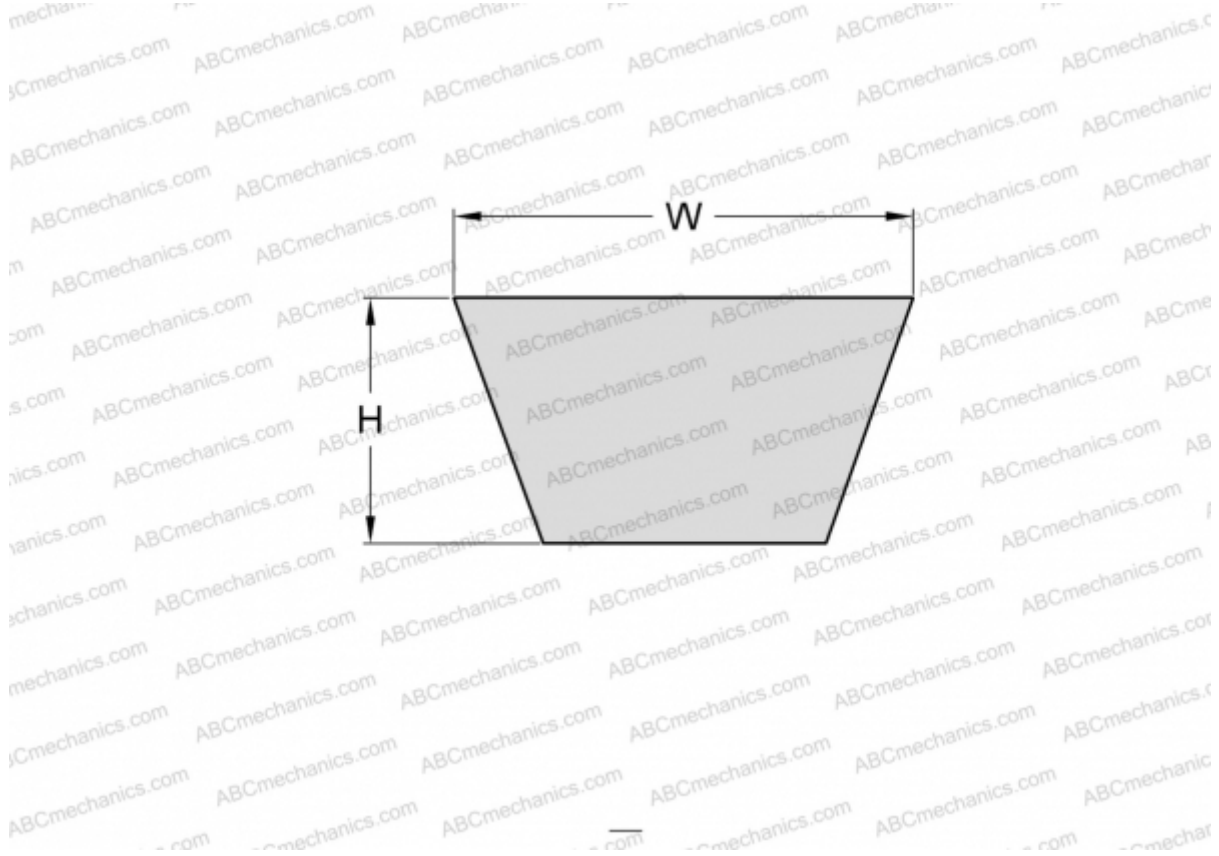

Technical specification

DIMENSIONS, MM

Estimated length	3550,000
Inner length	3505,000
Width, W	17,000
Height, H	11,000

MANUFACTURER

[SKF](#)